

# Wiring Accessories Offering

Saudi Arabia



# Index

Inora .....	4
Inora - Overview .....	5
Inora - Switches .....	6
Inora - Socket Outlets .....	8
Inora - Data Outlets .....	9
Inora - Function Control.....	10
Inora - FCU & Flex Outlets & Accessories .....	11
Framia .....	12
Framia - Overview.....	13
Framia - Switches.....	14
Framia - Socket Outlets .....	18
Framia - Data Outlets .....	19
Framia - Function Control.....	21
Framia - FCU & Flex Outlets .....	22
Framia - Accessories.....	23
Zenit .....	24
Zenit - Overview .....	25
Zenit - Complete Sets .....	26
Zenit - Modular System (Switches) .....	29
Zenit - Modular System (Frames).....	31
Zenit - Modular System (Function).....	34
Metal Clad .....	40
Metal Clad - Overview .....	40
Metal Clad - Switches.....	42
Metal Clad - Socket & Data Outlets / FCU & Flex Outlets / Accessories.....	43
Weatherproof Switches .....	44
Weatherproof - Switches Isolator .....	45
Weatherproof - IP66 & IP55 Covers .....	46



# Inora

Simplicity for timeless design

—  
Available in four colors – white,  
classic grey, starry black and royal  
gold – the simplicity of the Inora  
switches and socket outlets sets  
new standards for timeless  
design.

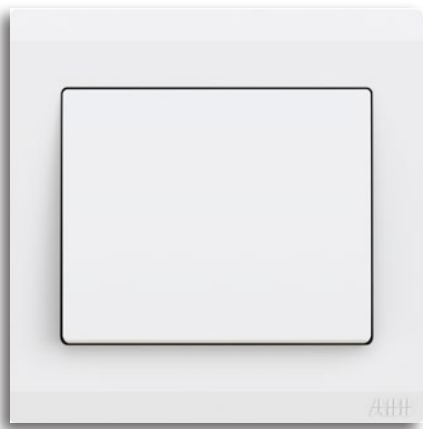

—  
01



—  
02



—  
03





—  
04

- 01 White
- 02 Classic grey - G
- 03 Starry black - 885
- 04 Royal gold - PG

# Inora

## Switches

Product	Article-No.	Order-No.	Pack/Qty
	<b>1 Gang 1 Way 10AX SWITCH</b> Rated voltage: 250V AC Rated current: 10AX		
White	BL101	2TCZ171001R0030	1
Classic Grey	BL101 - G	2TCZ171001R2230	1
Starry Black	BL101 - 885	2TCZ171001R4430	1
Royal Gold	BL101 - PG	2TCZ171001R1930	1

Product	Article-No.	Order-No.	Pack/Qty
	<b>1 Gang 2 Way 10AX SWITCH</b> Rated voltage: 250V AC Rated current: 10AX		
White	BL105	2TCZ171002R0030	1
Classic Grey	BL105 - G	2TCZ171002R2230	1
Starry Black	BL105 - 885	2TCZ171002R4430	1
Royal Gold	BL105 - PG	2TCZ171002R1930	1

	<b>2 Gang 1 Way 10AX SWITCH</b> Rated voltage: 250V AC Rated current: 10AX		
White	BL102	2TCZ171003R0030	1
Classic Grey	BL102 - G	2TCZ171003R2230	1
Starry Black	BL102 - 885	2TCZ171003R4430	1
Royal Gold	BL102 - PG	2TCZ171003R1930	1

	<b>2 Gang 2 Way 10AX SWITCH</b> Rated voltage: 250V AC Rated current: 10AX		
White	BL106	2TCZ171004R0030	1
Classic Grey	BL106 - G	2TCZ171004R2230	1
Starry Black	BL106 - 885	2TCZ171004R4430	1
Royal Gold	BL106 - PG	2TCZ171004R1930	1

	<b>3 Gang 1 Way 10AX SWITCH</b> Rated voltage: 250V AC Rated current: 10AX		
White	BL103	2TCZ171005R0030	1
Classic Grey	BL103 - G	2TCZ171005R2230	1
Starry Black	BL103 - 885	2TCZ171005R4430	1
Royal Gold	BL103 - PG	2TCZ171005R1930	1

	<b>3 Gang 2 Way 10AX SWITCH</b> Rated voltage: 250V AC Rated current: 10AX		
White	BL107	2TCZ171006R0030	1
Classic Grey	BL107 - G	2TCZ171006R2230	1
Starry Black	BL107 - 885	2TCZ171006R4430	1
Royal Gold	BL107 - PG	2TCZ171006R1930	1

	<b>4 Gang 1 Way 10AX SWITCH</b> Rated voltage: 250V AC Rated current: 10AX		
White	BL104	2TCZ171007R0030	1
Classic Grey	BL104 - G	2TCZ171007R2230	1
Starry Black	BL104 - 885	2TCZ171007R4430	1
Royal Gold	BL104 - PG	2TCZ171007R1930	1

	<b>4 Gang 2 Way 10AX SWITCH</b> Rated voltage: 250V AC Rated current: 10AX		
White	BL108	2TCZ171008R0030	1
Classic Grey	BL108 - G	2TCZ171008R2230	1
Starry Black	BL108 - 885	2TCZ171008R4430	1
Royal Gold	BL108 - PG	2TCZ171008R1930	1

	<b>1 Gang 1 Way DP witch, 20AX With LED</b> Rated voltage: 250V AC Rated current: 20AX		
White	BL111	2TCZ171096R0070	1
Classic Grey	BL111 - G	2TCZ171096R2270	1
Starry Black	BL111 - 885	2TCZ171096R4470	1
Royal Gold	BL111 - PG	2TCZ171096R1970	1

	<b>1 Gang 1 Way DP witch, 20AX With LED</b> Rated voltage: 250V AC Rated current: 20AX		
White	BL111S	2TCZ171020R0070	1
Classic Grey	BL111S - G	2TCZ171020R2270	1
Starry Black	BL111S - 885	2TCZ171020R4470	1
Royal Gold	BL111S - PG	2TCZ171020R1970	1

# Inora

## Switches

Product	Article-No.	Order-No.	Pack/Qty
	<b>2 Gang 1Way 45A DP SWITCH &amp; 13A SWITCH SOCKET WITH ILLUMINATION</b> Rated voltage: 250V AC Switch Rated Current: 45AX Socket Rated Current: 13A		
White	BL118	2TCZ171015R0090	1
Classic Grey	BL118 - G	2TCZ171015R2290	1
Starry Black	BL118 - 885	2TCZ171015R4490	1
Royal Gold	BL118 - PG	2TCZ171015R1990	1

	<b>1 Gang INTERMEDIATE 10AX SWITCH</b> Rated voltage: 250V AC Rated current: 10AX		
White	BL119	2TCZ171009R0030	1
Classic Grey	BL119 - G	2TCZ171009R2230	1
Starry Black	BL119 - 885	2TCZ171009R4430	1
Royal Gold	BL119 - PG	2TCZ171009R1930	1

	<b>1 Gang 1 Way 10A PUSH SWITCH</b> Rated voltage: 250V AC Rated current: 10A		
White	BL430	2TCZ171010R0030	1
Classic Grey	BL430 - G	2TCZ171010R2230	1
Starry Black	BL430 - 885	2TCZ171010R4430	1
Royal Gold	BL430 - PG	2TCZ171010R1930	1

	<b>1 Gang 1 Way 20AX DP SW WITH ILLUMINATION-MARKED WATER HEATER</b> Rated voltage: 250V AC Rated current: 20AX		
White	BL171WH	2TCZ171012R0075	1
Classic Grey	BL171WH - G	2TCZ171012R2275	1
Starry Black	BL171WH - 885	2TCZ171012R4475	1
Royal Gold	BL171WH - PG	2TCZ171012R1975	1

	<b>1 Gang 1 Way 45A DP SWITCH WITH ILLUMINATION</b> Rated voltage: 250V AC Rated current: 45A		
White	BL179	2TCZ171098R0090	1
Classic Grey	BL179 - G	2TCZ171098R2290	1
Starry Black	BL179 - 885	2TCZ171098R4490	1
Royal Gold	BL179 - PG	2TCZ171098R1990	1

Product	Article-No.	Order-No.	Pack/Qty
	<b>20A FLEX OUTLET</b> Rated voltage: 250V AC Rated current: 20AX		
White	BL120	2TCZ171099R0070	1
Classic Grey	BL120 - G	2TCZ171099R2270	1
Starry Black	BL120 - 885	2TCZ171099R4470	1
Royal Gold	BL120 - PG	2TCZ171099R1970	1

	<b>1 Gang INTERMEDIATE 10AX SWITCH</b> Rated voltage: 250V AC Rated current: 10AX		
White	BL119S	2TCZ171021R0030	1
Classic Grey	BL119S - G	2TCZ171021R2230	1
Starry Black	BL119S - 885	2TCZ171021R4430	1
Royal Gold	BL119S - PG	2TCZ171021R1930	1

	<b>1 Gang 1 Way 10A PUSH SWITCH- MARKED BELL</b> Rated voltage: 250V AC Rated current: 10A		
White	BL429	2TCZ171011R0030	1
Classic Grey	BL429 - G	2TCZ171011R2230	1
Starry Black	BL429 - 885	2TCZ171011R4430	1
Royal Gold	BL429 - PG	2TCZ171011R1930	1

	<b>BLIND CONTROL SWITCH 10A</b> Rated voltage: 250V AC Rated current: 10A		
White	BL149	2TCZ171026R0030	1
Classic Grey	BL149 - G	2TCZ171026R2230	1
Starry Black	BL149 - 885	2TCZ171026R4430	1
Royal Gold	BL149 - PG	2TCZ171026R1930	1

	<b>1 Gang 1 Way 20AX DP SWITCH WITH LED, MARKED WATER HEATER</b> Rated voltage: 250V AC Rated current: 20AX		
White	BL180WH	2TCZ171014R0070	1
Classic Grey	BL180WH - G	2TCZ171014R2270	1
Starry Black	BL180WH - 885	2TCZ171014R4470	1
Royal Gold	BL180WH - PG	2TCZ171014R1970	1

# Inora

## Socket outlets

Product	Article-No.	Order-No.	Pack/Qty
---------	-------------	-----------	----------



**1 Gang 13A SOCKET**  
 Rated voltage: 250V AC  
 Rated current: 13A

White	BL208	2TCZ172005R0040	1
Classic Grey	BL208 - G	2TCZ172005R2240	1
Starry Black	BL208 - 885	2TCZ172005R4440	1
Royal Gold	BL208 - PG	2TCZ172005R1940	1

Product	Article-No.	Order-No.	Pack/Qty
---------	-------------	-----------	----------



**1 Gang 13A SWITCHED SOCKET DP**  
 Rated voltage: 250V AC  
 Rated current: 13A

White	BL237	2TCZ172095R0040	1
Classic Grey	BL237 - G	2TCZ172095R2240	1
Starry Black	BL237 - 885	2TCZ172095R4440	1
Royal Gold	BL237 - PG	2TCZ172095R1940	1



**1 Gang 13A SWITCHED SOCKET DP WITH ILLUMINATION**  
 Rated voltage: 250V AC  
 Rated current: 13A

White	BL238	2TCZ172096R0040	1
Classic Grey	BL238 - G	2TCZ172096R2240	1
Starry Black	BL238 - 885	2TCZ172096R4440	1
Royal Gold	BL238 - PG	2TCZ172096R1940	1



**1 Gang 13A SWITCHED SOCKET DP WITH USB, TYPE A+C**  
 Rated voltage: 250V AC  
 Rated current: 13A

White	BL247	2TCZ172013R0040	1
Classic Grey	BL247 - G	2TCZ172013R2240	1
Starry Black	BL247 - 885	2TCZ172013R4440	1
Royal Gold	BL247 - PG	2TCZ172013R1940	1



**1 Gang BS SWITCHED SOCKET DP WITH USB, TYPE A\*2**  
 Rated voltage: 250V AC  
 Rated current: 13A

White	BL261	2TCZ172016R0040	1
Classic Grey	BL261 - G	2TCZ172016R2240	1
Starry Black	BL261 - 885	2TCZ172016R4440	1
Royal Gold	BL261 - PG	2TCZ172016R1940	1



**2 Gang 13A SOCKET**  
 Rated voltage: 250V AC  
 Rated current: 13A

White	BL260	2TCZ172006R0040	1
Classic Grey	BL260 - G	2TCZ172006R2240	1
Starry Black	BL260 - 885	2TCZ172006R4440	1
Royal Gold	BL260 - PG	2TCZ172006R1940	1

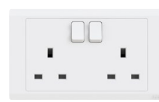

**2 Gang 13A SWITCHED SOCKET DP**  
 Rated voltage: 250V AC  
 Rated current: 13A

White	BL239	2TCZ172097R0040	1
Classic Grey	BL239 - G	2TCZ172097R2240	1
Starry Black	BL239 - 885	2TCZ172097R4440	1
Royal Gold	BL239 - PG	2TCZ172097R1940	1

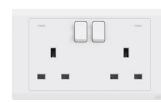

**2 Gang 13A SWITCHED SOCKET DP WITH ILLUMINATION**  
 Rated voltage: 250V AC  
 Rated current: 13A

White	BL240	2TCZ172098R0040	1
Classic Grey	BL240 - G	2TCZ172098R2240	1
Starry Black	BL240 - 885	2TCZ172098R4440	1
Royal Gold	BL240 - PG	2TCZ172098R1940	1

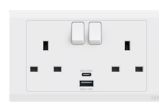

**2 Gang 13A SWITCHED SOCKET DP WITH USB, TYPE A+C**  
 Rated voltage: 250V AC  
 Rated current: 13A

White	BL248	2TCZ172014R0040	1
Classic Grey	BL248 - G	2TCZ172014R2240	1
Starry Black	BL248 - 885	2TCZ172014R4440	1
Royal Gold	BL248 - PG	2TCZ172014R1940	1

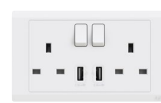

**2 Gang BS SWITCHED SOCKET DP WITH USB, TYPE A\*2**  
 Rated voltage: 250V AC  
 Rated current: 13A

White	BL262	2TCZ172017R0040	1
Classic Grey	BL262 - G	2TCZ172017R2240	1
Starry Black	BL262 - 885	2TCZ172017R4440	1
Royal Gold	BL262 - PG	2TCZ172017R1940	1

# Inora

## Data outlets

Product	Article-No.	Order-No.	Pack/Qty
---------	-------------	-----------	----------



**1Gang TV outlet**  
Dead-end feeder  
Frequency range: 5-1000MHz

White	BL301	2TCZ173001R0010	1
Classic Grey	BL301 - G	2TCZ173001R2210	1
Starry Black	BL301 - 885	2TCZ173001R4410	1
Royal Gold	BL301 - PG	2TCZ173001R1910	1

Product	Article-No.	Order-No.	Pack/Qty
---------	-------------	-----------	----------



**1 Gang SAT socket outlet**  
F-Type, isolated  
Frequency range: 5-1000MHz

White	BL308	2TCZ173099R0010	1
Classic Grey	BL308 - G	2TCZ173099R2210	1
Starry Black	BL308 - 885	2TCZ173099R4410	1
Royal Gold	BL308 - PG	2TCZ173099R1910	1



**2 Gang Data outlet**  
RJ45  
Cat.6a  
8-pole UTP

White	BL317	2TCZ173019R0010	1
Classic Grey	BL317 - G	2TCZ173019R2210	1
Starry Black	BL317 - 885	2TCZ173019R4410	1
Royal Gold	BL317 - PG	2TCZ173019R1910	1



**1 Gang Data outlet**  
RJ45  
Cat.6a  
8-pole UTP

White	BL318	2TCZ173020R0010	1
Classic Grey	BL318 - G	2TCZ173020R2210	1
Starry Black	BL318 - 885	2TCZ173020R4410	1
Royal Gold	BL318 - PG	2TCZ173020R1910	1



**1 Gang TELEPHONE OUTLET RJ11**  
RJ11 type connection  
4-pole UTP

White	BL321	2TCZ173006R0010	1
Classic Grey	BL321 - G	2TCZ173006R2210	1
Starry Black	BL321 - 885	2TCZ173006R4410	1
Royal Gold	BL321 - PG	2TCZ173006R1910	1



**2 Gang TELEPHONE OUTLET RJ11**  
RJ11 type connection  
4-pole UTP

White	BL322	2TCZ173012R0010	1
Classic Grey	BL322 - G	2TCZ173012R2210	1
Starry Black	BL322 - 885	2TCZ173012R4410	1
Royal Gold	BL322 - PG	2TCZ173012R1910	1



**2 Gang Data outlet**  
RJ45  
Cat.6  
8-pole UTP

White	BL329	2TCZ173014R0010	1
Classic Grey	BL329 - G	2TCZ173014R2210	1
Starry Black	BL329 - 885	2TCZ173014R4410	1
Royal Gold	BL329 - PG	2TCZ173014R1910	1



**1 Gang Data outlet**  
RJ45  
Cat.6  
8-pole UTP

White	BL333	2TCZ173008R0010	1
Classic Grey	BL333 - G	2TCZ173008R2210	1
Starry Black	BL333 - 885	2TCZ173008R4410	1
Royal Gold	BL333 - PG	2TCZ173008R1910	1



**1 Gang DATA OUTLET HOUSING**

White	BL331-H	2TCZ173017R0010	1
Classic Grey	BL331-H - G	2TCZ173017R2210	1
Starry Black	BL331-H - 885	2TCZ173017R4410	1
Royal Gold	BL331-H - PG	2TCZ173017R1910	1





**2 Gang DATA OUTLET HOUSING**

White	BL332-H	2TCZ173018R0010	1
Classic Grey	BL332-H - G	2TCZ173018R2210	1
Starry Black	BL332-H - 885	2TCZ173018R4410	1
Royal Gold	BL332-H - PG	2TCZ173018R1910	1

# Inora

## Function control

Product	Article-No.	Order-No.	Pack/Qty	
 <p><b>Shaver socket outlet</b> Input: 230V, 50Hz/60Hz Output: 115V/230V, 20VA</p>	White	BL401	2TCZ174002R0010	1
	Classic Grey	BL401 - G	2TCZ174002R2210	1
	Starry Black	BL401 - 885	2TCZ174002R4410	1
	Royal Gold	BL401 - PG	2TCZ174002R1910	1

 <p><b>Push button DND/MUR with bell symbol, 10A</b> Rated voltage: 250V AC Rated current: 10A Includes red / green indication and bell sign</p>	White	BL403	2TCZ174005R0030	1
	Classic Grey	BL403 - G	2TCZ174005R2230	1
	Starry Black	BL403 - 885	2TCZ174005R4430	1
	Royal Gold	BL403 - PG	2TCZ174005R1930	1

 <p><b>LED dimmer</b> Rated voltage: 220V-240V AC Frequency: 50-60Hz Load power range: 3-150VA <math>\mu</math> Load type: - Adjustable LED - Incandescent lamp - 220V main halogen lamp</p>	White	BL405	2TCZ174003R0010	1
	Classic Grey	BL405 - G	2TCZ174003R2210	1
	Starry Black	BL405 - 885	2TCZ174003R4410	1
	Royal Gold	BL405 - PG	2TCZ174003R1910	1

 <p><b>Fan regulator</b> Rated voltage: 220V AC Frequency: 50-60Hz Adjustment range: 500-25VA <math>\mu</math> (from high to low)</p>	White	BL422	2TCZ174009R0010	1
	Classic Grey	BL422 - G	2TCZ174009R2210	1
	Starry Black	BL422 - 885	2TCZ174009R4410	1
	Royal Gold	BL422 - PG	2TCZ174009R1910	1

Product	Article-No.	Order-No.	Pack/Qty	
 <p><b>Electronic Card switch, 16A with LED</b> Rated voltage: 250V AC Rated current: 16A Load compatibility: - Incandescent lamps: 4000W - Fluorescent lamps: 200VA - Motors: 200VA - Self-ballasted lamps: 100VA Time delay: 30s~45s</p>	White	BL402	2TCZ174004R0060	1
	Classic Grey	BL402 - G	2TCZ174004R2260	1
	Starry Black	BL402 - 885	2TCZ174004R4460	1
	Royal Gold	BL402 - PG	2TCZ174004R1960	1

 <p><b>2 Gang Switch DND/MUR with LED, 10A</b> Rated voltage: 250V AC Rated current: 10A Interlocked gangs Includes red / green indication and bell sign</p>	White	BL493	2TCZ174006R0030	1
	Classic Grey	BL493 - G	2TCZ174006R2230	1
	Starry Black	BL493 - 885	2TCZ174006R4430	1
	Royal Gold	BL493 - PG	2TCZ174006R1930	1

 <p><b>Rotary dimmer</b> Rated voltage: 220V AC Frequency: 50-60Hz Adjustment range: 25-500VA <math>\mu</math> Load type: - Incandescent lamp - 220V main halogen lamp</p>	White	BL322	2TCZ173012R0010	1
	Classic Grey	BL322 - G	2TCZ173012R2210	1
	Starry Black	BL322 - 885	2TCZ173012R4410	1
	Royal Gold	BL322 - PG	2TCZ173012R1910	1

## Inora

### FCU & Flex outlets & Accessories

Product	Article-No.	Order-No.	Pack/Qty
	<b>Fused connection unit, 13A</b> Rated voltage: 250V AC Rated current: 13A		
White	BL506	2TCZ175003R0040	1
Classic Grey	BL506 - G	2TCZ175003R2240	1
Starry Black	BL506 - 885	2TCZ175003R4440	1
Royal Gold	BL506 - PG	2TCZ175003R1940	1

	<b>Switched Fused connection unit, 13A</b> Rated voltage: 250V AC Rated current: 13A Double pole switch		
White	BL508	2TCZ175099R0040	1
Classic Grey	BL508 - G	2TCZ175099R2240	1
Starry Black	BL508 - 885	2TCZ175099R4440	1
Royal Gold	BL508 - PG	2TCZ175099R1940	1

	<b>1 Gang Blank Plate</b>		
White	BL504	2TCZ175001R0010	1
Classic Grey	BL504 - G	2TCZ175001R2210	1
Starry Black	BL504 - 885	2TCZ175001R4410	1
Royal Gold	BL504 - PG	2TCZ175001R1910	1

Product	Article-No.	Order-No.	Pack/Qty
	<b>Switched Fused connection unit with LED, 13A</b> Rated voltage: 250V AC Rated current: 13A Double pole switch LED indicator		
White	BL507	2TCZ175004R0040	1
Classic Grey	BL507 - G	2TCZ175004R2240	1
Starry Black	BL507 - 885	2TCZ175004R4440	1
Royal Gold	BL507 - PG	2TCZ175004R1940	1

	<b>Flex Outlet 45A</b> Rated voltage: 250V AC Rated current: 45A		
White	BL590	2TCZ175006R0090	1
Classic Grey	BL590 - G	2TCZ175006R2290	1
Starry Black	BL590 - 885	2TCZ175006R4490	1
Royal Gold	BL590 - PG	2TCZ175006R1990	1

	<b>2 Gang Blank Plate</b>		
White	BL505	2TCZ175002R0010	1
Classic Grey	BL505 - G	2TCZ175002R2210	1
Starry Black	BL505 - 885	2TCZ175002R4410	1
Royal Gold	BL505 - PG	2TCZ175002R1910	1



# Framia

Frameless elegance, harmony in every touch

---

## Minimalist aesthetics, trendsetting pioneer

The smooth frameless exterior, with a 7.8 mm slim body, integrates minimalist aesthetics into your daily life, becoming an art piece on the wall.



01



02

- 01 White
- 02 Matt white - WM
- 03 Space grey - SG
- 04 Matt black - MB
- 05 Champagne gold - CH



03





04





05

## Framia Switches

Product	Article-No.	Order-No.	Pack/Qty
	<b>1 Gang 1 Way switch, 16AX</b> Rated voltage: 250V AC Rated current: 16AX		
White	BC127	2TCZ211001R0060	1
Matt white	BC127-WM	2TCZ211001R3960	1
Space grey	BC127-SG	2TCZ211001R6360	1
Matt black	BC127-MB	2TCZ211001R4460	1
Champagne gold	BC127-CH	2TCZ211001R4160	1

	<b>2 Gang 1 Way switch, 16AX</b> Rated voltage: 250V AC Rated current: 16AX		
White	BC122	2TCZ211002R0060	1
Matt white	BC122-WM	2TCZ211002R3960	1
Space grey	BC122-SG	2TCZ211002R6360	1
Matt black	BC122-MB	2TCZ211002R4460	1
Champagne gold	BC122-CH	2TCZ211002R4160	1

	<b>3 Gang 1 Way switch, 16AX</b> Rated voltage: 250V AC Rated current: 16AX		
White	BC123	2TCZ211003R0060	1
Matt white	BC123-WM	2TCZ211003R3960	1
Space grey	BC123-SG	2TCZ211003R6360	1
Matt black	BC123-MB	2TCZ211003R4460	1
Champagne gold	BC123-CH	2TCZ211003R4160	1

	<b>4 Gang 1 Way switch, 16AX</b> Rated voltage: 250V AC Rated current: 16AX		
White	BC124	2TCZ211004R0060	1
Matt white	BC124-WM	2TCZ211004R3960	1
Space grey	BC124-SG	2TCZ211004R6360	1
Matt black	BC124-MB	2TCZ211004R4460	1
Champagne gold	BC124-CH	2TCZ211004R4160	1

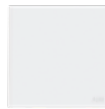
Product	Article-No.	Order-No.	Pack/Qty
	<b>1 Gang 2 Way switch, 16AX</b> Rated voltage: 250V AC Rated current: 16AX		
White	BC125	2TCZ211005R0060	1
Matt white	BC125-WM	2TCZ211005R3960	1
Space grey	BC125-SG	2TCZ211005R6360	1
Matt black	BC125-MB	2TCZ211005R4460	1
Champagne gold	BC125-CH	2TCZ211005R4160	1

	<b>2 Gang 2 Way switch, 16AX</b> Rated voltage: 250V AC Rated current: 16AX		
White	BC126	2TCZ211006R0060	1
Matt white	BC126-WM	2TCZ211006R3960	1
Space grey	BC126-SG	2TCZ211006R6360	1
Matt black	BC126-MB	2TCZ211006R4460	1
Champagne gold	BC126-CH	2TCZ211006R4160	1

	<b>3 Gang 2 Way switch, 16AX</b> Rated voltage: 250V AC Rated current: 16AX		
White	BC121	2TCZ211007R0060	1
Matt white	BC121-WM	2TCZ211007R3960	1
Space grey	BC121-SG	2TCZ211007R6360	1
Matt black	BC121-MB	2TCZ211007R4460	1
Champagne gold	BC121-CH	2TCZ211007R4160	1

	<b>4 Gang 2 Way switch, 16AX</b> Rated voltage: 250V AC Rated current: 16AX		
White	BC141	2TCZ211008R0060	1
Matt white	BC141-WM	2TCZ211008R3960	1
Space grey	BC141-SG	2TCZ211008R6360	1
Matt black	BC141-MB	2TCZ211008R4460	1
Champagne gold	BC141-CH	2TCZ211008R4160	1

## Framia Switches

Product	Article-No.	Order-No.	Pack/Qty
---------	-------------	-----------	----------



**1 Gang 1 Way switch, 20AX**  
Rated voltage: 250V AC  
Rated current: 20AX

White	BC110	2TCZ211010R0070	1
Matt white	BC110-WM	2TCZ211010R3970	1
Space grey	BC110-SG	2TCZ211010R6370	1
Matt black	BC110-MB	2TCZ211010R4470	1
Champagne gold	BC110-CH	2TCZ211010R4170	1



**2 Gang 1 Way switch, 20AX**  
Rated voltage: 250V AC  
Rated current: 20AX

White	BC114	2TCZ211012R0070	1
Matt white	BC114-WM	2TCZ211012R3970	1
Space grey	BC114-SG	2TCZ211012R6370	1
Matt black	BC114-MB	2TCZ211012R4470	1
Champagne gold	BC114-CH	2TCZ211012R4170	1



**1 Gang 1 Way DP switch, 20AX**  
Rated voltage: 250V AC  
Rated current: 20AX  
Marked "ON"

White	BC111	2TCZ211014R0070	1
Matt white	BC111-WM	2TCZ211014R3970	1
Space grey	BC111-SG	2TCZ211014R6370	1
Matt black	BC111-MB	2TCZ211014R4470	1
Champagne gold	BC111-CH	2TCZ211014R4170	1



**1 Gang 1 Way DP switch with LED, 20AX**  
Rated voltage: 250V AC  
Rated current: 20AX  
LED indicator  
Marked "ON"

White	BC171	2TCZ211015R0070	1
Matt white	BC171-WM	2TCZ211015R3970	1
Space grey	BC171-SG	2TCZ211015R6370	1
Matt black	BC171-MB	2TCZ211015R4470	1
Champagne gold	BC171-CH	2TCZ211015R4170	1

Product	Article-No.	Order-No.	Pack/Qty
---------	-------------	-----------	----------



**1 Gang 2 Way switch, 20AX**  
Rated voltage: 250V AC  
Rated current: 20AX

White	BC112	2TCZ211011R0070	1
Matt white	BC112-WM	2TCZ211011R3970	1
Space grey	BC112-SG	2TCZ211011R6370	1
Matt black	BC112-MB	2TCZ211011R4470	1
Champagne gold	BC112-CH	2TCZ211011R4170	1



**2 Gang 2 Way switch, 20AX**  
Rated voltage: 250V AC  
Rated current: 20AX

White	BC115	2TCZ211013R0070	1
Matt white	BC115-WM	2TCZ211013R3970	1
Space grey	BC115-SG	2TCZ211013R6370	1
Matt black	BC115-MB	2TCZ211013R4470	1
Champagne gold	BC115-CH	2TCZ211013R4170	1



**2 Gang 1 Way DP switch, 20AX**  
Rated voltage: 250V AC  
Rated current: 20AX  
Marked "ON"

White	BC113	2TCZ211028R0070	1
Matt white	BC113-WM	2TCZ211028R3970	1
Space grey	BC113-SG	2TCZ211028R6370	1
Matt black	BC113-MB	2TCZ211028R4470	1
Champagne gold	BC113-CH	2TCZ211028R4170	1





**2 Gang 1 Way DP switch with LED, 20AX**  
Rated voltage: 250V AC  
Rated current: 20AX  
LED indicator  
Marked "ON"

White	BC178	2TCZ211029R0070	1
Matt white	BC178-WM	2TCZ211029R3970	1
Space grey	BC178-SG	2TCZ211029R6370	1
Matt black	BC178-MB	2TCZ211029R4470	1
Champagne gold	BC178-CH	2TCZ211029R4170	1

## Framia Switches

Product	Article-No.	Order-No.	Pack/Qty
	<b>1 Gang 1 Way DP switch with LED, marked "Waterheater", 20AX</b> Rated voltage: 250V AC Rated current: 20AX LED indicator Marked "ON" & "Waterheater"		
White	BC171WH	2TCZ211016R0070	1
Matt white	BC171WH-WM	2TCZ211016R3970	1
Space grey	BC171WH-SG	2TCZ211016R6370	1
Matt black	BC171WH-MB	2TCZ211016R4470	1
Champagne gold	BC171WH-CH	2TCZ211016R4170	1

	<b>1 Gang 1 Way DP switch with LED, 32A</b> Rated voltage: 250V AC Rated current: 32A LED indicator		
White	BC176	2TCZ211018R0090	1
Matt white	BC176-WM	2TCZ211018R3990	1
Space grey	BC176-SG	2TCZ211018R6390	1
Matt black	BC176-MB	2TCZ211018R4490	1
Champagne gold	BC176-CH	2TCZ211018R4190	1

	<b>1 Gang 1 Way DP switch with LED, 32A</b> Rated voltage: 250V AC Rated current: 32A LED indicator		
White	BC176W	2TCZ211018R0091	1
Matt white	BC176W-WM	2TCZ211018R3991	1
Space grey	BC176W-SG	2TCZ211018R6391	1
Matt black	BC176W-MB	2TCZ211018R4491	1
Champagne gold	BC176W-CH	2TCZ211018R4191	1

	<b>1 Gang 1 Way push switch, 10A</b> Rated voltage: 250V AC Rated current: 10A		
White	BC430	2TCZ211021R0030	1
Matt white	BC430-WM	2TCZ211021R3930	1
Space grey	BC430-SG	2TCZ211021R6330	1
Matt black	BC430-MB	2TCZ211021R4430	1
Champagne gold	BC430-CH	2TCZ211021R4130	1

Product	Article-No.	Order-No.	Pack/Qty
	<b>1 Gang 2 Way DP switch with LED, marked "Waterheater", 20AX</b> Rated voltage: 250V AC Rated current: 20AX LED indicator Marked "ON" & "Waterheater"		
White	BC180	2TCZ211017R0070	1
Matt white	BC180-WM	2TCZ211017R3970	1
Space grey	BC180-SG	2TCZ211017R6370	1
Matt black	BC180-MB	2TCZ211017R4470	1
Champagne gold	BC180-CH	2TCZ211017R4170	1

	<b>1 Gang 1 Way DP switch with LED, 45A</b> Rated voltage: 250V AC Rated current: 45A LED indicator		
White	BC177	2TCZ211019R0090	1
Matt white	BC177-WM	2TCZ211019R3990	1
Space grey	BC177-SG	2TCZ211019R6390	1
Matt black	BC177-MB	2TCZ211019R4490	1
Champagne gold	BC177-CH	2TCZ211019R4190	1

	<b>1 Gang 1 Way DP switch with LED, 45A</b> Rated voltage: 250V AC Rated current: 45A LED indicator		
White	BC177W	2TCZ211019R0091	1
Matt white	BC177W-WM	2TCZ211019R3991	1
Space grey	BC177W-SG	2TCZ211019R6391	1
Matt black	BC177W-MB	2TCZ211019R4491	1
Champagne gold	BC177W-CH	2TCZ211019R4191	1

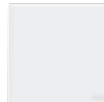
	<b>1 Gang 2 Way push switch, 10A</b> Rated voltage: 250V AC Rated current: 10A		
White	BC456	2TCZ211022R0030	1
Matt white	BC456-WM	2TCZ211022R3930	1
Space grey	BC456-SG	2TCZ211022R6330	1
Matt black	BC456-MB	2TCZ211022R4430	1
Champagne gold	BC456-CH	2TCZ211022R4130	1

## Framia Switches

Product	Article-No.	Order-No.	Pack/Qty
---------	-------------	-----------	----------



**2 Gang 1 Way push switch, 10A**  
Rated voltage: 250V AC  
Rated current: 10A

White	BC438	2TCZ211023R0030	1
Matt white	BC438-WM	2TCZ211023R3930	1
Space grey	BC438-SG	2TCZ211023R6330	1
Matt black	BC438-MB	2TCZ211023R4430	1
Champagne gold	BC438-CH	2TCZ211023R4130	1

Product	Article-No.	Order-No.	Pack/Qty
---------	-------------	-----------	----------



**3 Gang 1 Way push switch, 10A**  
Rated voltage: 250V AC  
Rated current: 10A

White	BC439	2TCZ211030R0030	1
Matt white	BC439-WM	2TCZ211030R3930	1
Space grey	BC439-SG	2TCZ211030R6330	1
Matt black	BC439-MB	2TCZ211030R4430	1
Champagne gold	BC439-CH	2TCZ211030R4130	1



**Push switch with bell symbol, 10A**  
Rated voltage: 250V AC  
Rated current: 10A  
Bell symbol

White	BC429	2TCZ211020R0030	1
Matt white	BC429-WM	2TCZ211020R3930	1
Space grey	BC429-SG	2TCZ211020R6330	1
Matt black	BC429-MB	2TCZ211020R4430	1
Champagne gold	BC429-CH	2TCZ211020R4130	1



**Switch blind control**  
Rated voltage: 250V AC  
Rated current: 10A

White	BC149	2TCZ211024R0030	1
Matt white	BC149-WM	2TCZ211024R3930	1
Space grey	BC149-SG	2TCZ211024R6330	1
Matt black	BC149-MB	2TCZ211024R4430	1
Champagne gold	BC149-CH	2TCZ211024R4130	1



**Intermediate switch, 16AX**  
Rated voltage: 250V AC  
Rated current: 16AX

White	BC150	2TCZ211009R0060	1
Matt white	BC150-WM	2TCZ211009R3960	1
Space grey	BC150-SG	2TCZ211009R6360	1
Matt black	BC150-MB	2TCZ211009R4460	1
Champagne gold	BC150-CH	2TCZ211009R4160	1



**2 Gang 1 Way DP 45A switch & 13A switched socket outlet with LED**  
Rated voltage: 250V AC  
Rated current (socket): 13A  
Rated current (switch): 45A  
LED indicator

White	BC118	2TCZ211025R0090	1
Matt white	BC118-WM	2TCZ211025R3990	1
Space grey	BC118-SG	2TCZ211025R6390	1
Matt black	BC118-MB	2TCZ211025R4490	1
Champagne gold	BC118-CH	2TCZ211025R4190	1

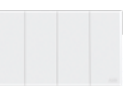

**4 Gang 2 Way switch in 6x3 Size, 16AX**  
Rated voltage: 250V AC  
Rated current: 16AX  
Size: in 6x3

White	BC191	2TCZ211026R0060	1
Matt white	BC191-WM	2TCZ211026R3960	1
Space grey	BC191-SG	2TCZ211026R6360	1
Matt black	BC191-MB	2TCZ211026R4460	1
Champagne gold	BC191-CH	2TCZ211026R4160	1

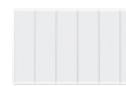

**6 Gang 2 Way switch in 6x3 Size, 16AX**  
Rated voltage: 250V AC  
Rated current: 16AX  
Size: in 6x3

White	BC198	2TCZ211027R0060	1
Matt white	BC198-WM	2TCZ211027R3960	1
Space grey	BC198-SG	2TCZ211027R6360	1
Matt black	BC198-MB	2TCZ211027R4460	1
Champagne gold	BC198-CH	2TCZ211027R4160	1

## Framia

### Socket outlets

Product	Article-No.	Order-No.	Pack/Qty
---------	-------------	-----------	----------



**1 Gang unswitched socket outlet, 13A**  
 Rated voltage: 250V AC  
 Rated current: 13A  
 Includes child safety shutter

White	BC208	2TCZ212001R0040	1
Matt white	BC208-WM	2TCZ212001R3940	1
Space grey	BC208-SG	2TCZ212001R6340	1
Matt black	BC208-MB	2TCZ212001R4440	1
Champagne gold	BC208-CH	2TCZ212001R4140	1



**1 Gang DP switched socket outlet, 13A**  
 Rated voltage: 250V AC  
 Rated current: 13A  
 Double pole switch  
 Includes child safety shutter

White	BC237	2TCZ212004R0040	1
Matt white	BC237-WM	2TCZ212004R3940	1
Space grey	BC237-SG	2TCZ212004R6340	1
Matt black	BC237-MB	2TCZ212004R4440	1
Champagne gold	BC237-CH	2TCZ212004R4140	1



**1 Gang DP switched socket outlet with LED, 13A**  
 Rated voltage: 250V AC  
 Rated current: 13A  
 Double pole switch  
 LED indicator  
 Includes child safety shutter

White	BC238	2TCZ212005R0040	1
Matt white	BC238-WM	2TCZ212005R3940	1
Space grey	BC238-SG	2TCZ212005R6340	1
Matt black	BC238-MB	2TCZ212005R4440	1
Champagne gold	BC238-CH	2TCZ212005R4140	1



**1 Gang DP switched socket outlet with USB Type A+C, 13A**  
 Rated voltage: 250V AC  
 Rated current: 13A  
 Double pole switch  
 USB-C: 20W Max.  
 USB-A: 18W Max.  
 USB-A+C: 15W Max.  
 Includes child safety shutter

White	BC247	2TCZ212011R0040	1
Matt white	BC247-WM	2TCZ212011R3940	1
Space grey	BC247-SG	2TCZ212011R6340	1
Matt black	BC247-MB	2TCZ212011R4440	1
Champagne gold	BC247-CH	2TCZ212011R4140	1

Product	Article-No.	Order-No.	Pack/Qty
---------	-------------	-----------	----------



**2 Gang unswitched socket outlet, 13A**  
 Rated voltage: 250V AC  
 Rated current: 13A  
 Includes child safety shutter

White	BC260	2TCZ212006R0040	1
Matt white	BC260-WM	2TCZ212006R3940	1
Space grey	BC260-SG	2TCZ212006R6340	1
Matt black	BC260-MB	2TCZ212006R4440	1
Champagne gold	BC260-CH	2TCZ212006R4140	1



**2 Gang DP switched socket outlet, 13A**  
 Rated voltage: 250V AC  
 Rated current: 13A  
 Double pole switch  
 Includes child safety shutter

White	BC239	2TCZ212009R0040	1
Matt white	BC239-WM	2TCZ212009R3940	1
Space grey	BC239-SG	2TCZ212009R6340	1
Matt black	BC239-MB	2TCZ212009R4440	1
Champagne gold	BC239-CH	2TCZ212009R4140	1



**2 Gang DP switched socket outlet with LED, 13A**  
 Rated voltage: 250V AC  
 Rated current: 13A  
 Double pole switch  
 LED indicator  
 Includes child safety shutter

White	BC240	2TCZ212010R0040	1
Matt white	BC240-WM	2TCZ212010R3940	1
Space grey	BC240-SG	2TCZ212010R6340	1
Matt black	BC240-MB	2TCZ212010R4440	1
Champagne gold	BC240-CH	2TCZ212010R4140	1





**2 Gang DP switched socket outlet with USB Type A+C, 13A**  
 Rated voltage: 250V AC  
 Rated current: 13A  
 Double pole switch  
 USB-C: 20W Max.  
 USB-A: 18W Max.  
 USB-A+C: 15W Max.  
 Includes child safety shutter

White	BC248	2TCZ212012R0040	1
Matt white	BC248-WM	2TCZ212012R3940	1
Space grey	BC248-SG	2TCZ212012R6340	1
Matt black	BC248-MB	2TCZ212012R4440	1
Champagne gold	BC248-CH	2TCZ212012R4140	1

## Framia

### Data outlets

Product	Article-No.	Order-No.	Pack/Qty
	<b>1Gang TV outlet</b> Dead-end feeder Frequency range: 5-1000MHz		
White	BC301	2TCZ213001R0010	1
Matt white	BC301-WM	2TCZ213001R3910	1
Space grey	BC301-SG	2TCZ213001R6310	1
Matt black	BC301-MB	2TCZ213001R4410	1
Champagne gold	BC301-CH	2TCZ213001R4110	1

Product	Article-No.	Order-No.	Pack/Qty
	<b>1 Gang SAT socket outlet</b> F-Type, isolated Frequency range: 5-1000MHz		
White	BC309	2TCZ213002R0010	1
Matt white	BC309-WM	2TCZ213002R3910	1
Space grey	BC309-SG	2TCZ213002R6310	1
Matt black	BC309-MB	2TCZ213002R4410	1
Champagne gold	BC309-CH	2TCZ213002R4110	1

	<b>2 Gang TV &amp; FM outlet</b> Dead-end feeder Frequency range: 5-1000MHz		
White	BC312	2TCZ213004R0010	1
Matt white	BC312-WM	2TCZ213004R3910	1
Space grey	BC312-SG	2TCZ213004R6310	1
Matt black	BC312-MB	2TCZ213004R4410	1
Champagne gold	BC312-CH	2TCZ213004R4110	1

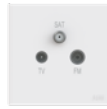
	<b>3 Gang TV, SAT &amp; FM outlet</b> Dead-end feeder Frequency range: 5-1000MHz F-Type, isolated		
White	BC313	2TCZ213003R0010	1
Matt white	BC313-WM	2TCZ213003R3910	1
Space grey	BC313-SG	2TCZ213003R6310	1
Matt black	BC313-MB	2TCZ213003R4410	1
Champagne gold	BC313-CH	2TCZ213003R4110	1

	<b>1 Gang Telephone outlet</b> RJ11 type connection 4-pole UTP		
White	BC321	2TCZ213005R0010	1
Matt white	BC321-WM	2TCZ213005R3910	1
Space grey	BC321-SG	2TCZ213005R6310	1
Matt black	BC321-MB	2TCZ213005R4410	1
Champagne gold	BC321-CH	2TCZ213005R4110	1

	<b>2 Gang Telephone outlet</b> RJ11 type connection 4-pole UTP		
White	BC322	2TCZ213006R0010	1
Matt white	BC322-WM	2TCZ213006R3910	1
Space grey	BC322-SG	2TCZ213006R6310	1
Matt black	BC322-MB	2TCZ213006R4410	1
Champagne gold	BC322-CH	2TCZ213006R4110	1

	<b>2 Gang TV/Telephone outlet</b> Frequency range: 5-1000MHz RJ11 type connection		
White	BC324	2TCZ213007R0010	1
Matt white	BC324-WM	2TCZ213007R3910	1
Space grey	BC324-SG	2TCZ213007R6310	1
Matt black	BC324-MB	2TCZ213007R4410	1
Champagne gold	BC324-CH	2TCZ213007R4110	1

	<b>2 Gang TV/Data outlet</b> Frequency range: 5-1000MHz RJ45 Cat.5e 8-pole UTP		
White	BC325	2TCZ213008R0010	1
Matt white	BC325-WM	2TCZ213008R3910	1
Space grey	BC325-SG	2TCZ213008R6310	1
Matt black	BC325-MB	2TCZ213008R4410	1
Champagne gold	BC325-CH	2TCZ213008R4110	1

## Framia

### Data outlets

Product	Article-No.	Order-No.	Pack/Qty
	<b>2 Gang Telephone &amp; Data outlet</b> RJ45 Cat.5e 8-pole UTP		
White	BC323	2TCZ213009R0010	1
Matt white	BC323-WM	2TCZ213009R3910	1
Space grey	BC323-SG	2TCZ213009R6310	1
Matt black	BC323-MB	2TCZ213009R4410	1
Champagne gold	BC323-CH	2TCZ213009R4110	1

	<b>2 Gang Data outlet</b> RJ45 Cat.5e 8-pole UTP		
White	BC332	2TCZ213011R0010	1
Matt white	BC332-WM	2TCZ213011R3910	1
Space grey	BC332-SG	2TCZ213011R6310	1
Matt black	BC332-MB	2TCZ213011R4410	1
Champagne gold	BC332-CH	2TCZ213011R4110	1

	<b>2 Gang Data outlet</b> RJ45 Cat.6 8-pole UTP		
White	BC329	2TCZ213013R0010	1
Matt white	BC329-WM	2TCZ213013R3910	1
Space grey	BC329-SG	2TCZ213013R6310	1
Matt black	BC329-MB	2TCZ213013R4410	1
Champagne gold	BC329-CH	2TCZ213013R4110	1

	<b>2 Gang Data outlet</b> RJ45 Cat.6a 8-pole UTP		
White	BC317	2TCZ213015R0010	1
Matt white	BC317-WM	2TCZ213015R3910	1
Space grey	BC317-SG	2TCZ213015R6310	1
Matt black	BC317-MB	2TCZ213015R4410	1
Champagne gold	BC317-CH	2TCZ213015R4110	1

Product	Article-No.	Order-No.	Pack/Qty
	<b>1 Gang Data outlet</b> RJ45 Cat.5e 8-pole UTP		
White	BC331	2TCZ213010R0010	1
Matt white	BC331-WM	2TCZ213010R3910	1
Space grey	BC331-SG	2TCZ213010R6310	1
Matt black	BC331-MB	2TCZ213010R4410	1
Champagne gold	BC331-CH	2TCZ213010R4110	1

	<b>1 Gang Data outlet</b> RJ45 Cat.6 8-pole UTP		
White	BC333	2TCZ213012R0010	1
Matt white	BC333-WM	2TCZ213012R3910	1
Space grey	BC333-SG	2TCZ213012R6310	1
Matt black	BC333-MB	2TCZ213012R4410	1
Champagne gold	BC333-CH	2TCZ213012R4110	1

	<b>1 Gang Data outlet</b> RJ45 Cat.6a 8-pole UTP		
White	BC318	2TCZ213014R0010	1
Matt white	BC318-WM	2TCZ213014R3910	1
Space grey	BC318-SG	2TCZ213014R6310	1
Matt black	BC318-MB	2TCZ213014R4410	1
Champagne gold	BC318-CH	2TCZ213014R4110	1

	<b>1 Gang Data outlet Housing</b>		
White	BC331-H	2TCZ213016R0010	1
Matt white	BC331-H-WM	2TCZ213016R3910	1
Space grey	BC331-H-SG	2TCZ213016R6310	1
Matt black	BC331-H-MB	2TCZ213016R4410	1
Champagne gold	BC331-H-CH	2TCZ213016R4110	1

## Framia

### Function control

Product	Article-No.	Order-No.	Pack/Qty
	<b>Shaver socket outlet</b> Input: 230V, 50Hz/60Hz Output: 115V/230V, 20VA		
White	BC401	2TCZ214001R0010	1
Matt white	BC401-WM	2TCZ214001R3910	1
Space grey	BC401-SG	2TCZ214001R6310	1
Matt black	BC401-MB	2TCZ214001R4410	1
Champagne gold	BC401-CH	2TCZ214001R4110	1

	<b>Push button DND/MUR with bell symbol, 10A</b> Rated voltage: 250V AC Rated current: 10A Includes red / green indication and bell sign		
White	BC403	2TCZ214003R0030	1
Matt white	BC403-WM	2TCZ214003R3930	1
Space grey	BC403-SG	2TCZ214003R6330	1
Matt black	BC403-MB	2TCZ214003R4430	1
Champagne gold	BC403-CH	2TCZ214003R4130	1

	<b>LED dimmer</b> Rated voltage: 220V-240V AC Frequency: 50-60Hz Load power range: 3-150VA $\mu$ Load type: - Adjustable LED - Incandescent lamp - 220V main halogen lamp		
White	BC405	2TCZ214006R0010	1
Matt white	BC405-WM	2TCZ214006R3910	1
Space grey	BC405-SG	2TCZ214006R6310	1
Matt black	BC405-MB	2TCZ214006R4410	1
Champagne gold	BC405-CH	2TCZ214006R4110	1

	<b>Fan regulator</b> Rated voltage: 220V AC Frequency: 50-60Hz Adjustment range: 500-25VA $\mu$ (from high to low)		
White	BC422	2TCZ214007R0010	1
Matt white	BC422-WM	2TCZ214007R3910	1
Space grey	BC422-SG	2TCZ214007R6310	1
Matt black	BC422-MB	2TCZ214007R4410	1
Champagne gold	BC422-CH	2TCZ214007R4110	1

Product	Article-No.	Order-No.	Pack/Qty
	<b>Electronic Card switch, 16A</b> Rated voltage: 250V AC Rated current: 16A Load compatibility: - Incandescent lamps: 4000W - Motors: 200VA - Fluorescent lamps: 200VA - Self-ballasted lamps: 100VA Time delay: 30s~45s Includes LED indicator		
White	BC402	2TCZ214002R0060	1
Matt white	BC402-WM	2TCZ214002R3960	1
Space grey	BC402-SG	2TCZ214002R6360	1
Matt black	BC402-MB	2TCZ214002R4460	1
Champagne gold	BC402-CH	2TCZ214002R4160	1

	<b>2 Gang Switch DND/MUR with LED, 10A</b> Rated voltage: 250V AC Rated current: 10A Interlocked gangs Includes red / green indication and bell sign		
White	BC493	2TCZ214004R0030	1
Matt white	BC493-WM	2TCZ214004R3930	1
Space grey	BC493-SG	2TCZ214004R6330	1
Matt black	BC493-MB	2TCZ214004R4430	1
Champagne gold	BC493-CH	2TCZ214004R4130	1

	<b>Rotary dimmer</b> Rated voltage: 220V AC Frequency: 50-60Hz Adjustment range: 25-500VA $\mu$ Load type: - Incandescent lamp - 220V main halogen lamp		
White	BC412	2TCZ214005R0010	1
Matt white	BC412-WM	2TCZ214005R3910	1
Space grey	BC412-SG	2TCZ214005R6310	1
Matt black	BC412-MB	2TCZ214005R4410	1
Champagne gold	BC412-CH	2TCZ214005R4110	1

## Framia

### FCU & Flex outlets

Product	Article-No.	Order-No.	Pack/Qty
	<b>Fused connection unit, 13A</b> Rated voltage: 250V AC Rated current: 13A		
White	BC506	2TCZ215001R0040	1
Matt white	BC506-WM	2TCZ215001R3940	1
Space grey	BC506-SG	2TCZ215001R6340	1
Matt black	BC506-MB	2TCZ215001R4440	1
Champagne gold	BC506-CH	2TCZ215001R4140	1

	<b>Switched Fused connection unit, 13A</b> Rated voltage: 250V AC Rated current: 13A Double pole switch		
White	BC508	2TCZ215011R0040	1
Matt white	BC508-WM	2TCZ215011R3940	1
Space grey	BC508-SG	2TCZ215011R6340	1
Matt black	BC508-MB	2TCZ215011R4440	1
Champagne gold	BC508-CH	2TCZ215011R4140	1

	<b>Flex outlet 25A</b> Rated voltage: 250V AC Rated current: 25A		
White	BC589	2TCZ215004R0070	1
Matt white	BC589-WM	2TCZ215004R3970	1
Space grey	BC589-SG	2TCZ215004R6370	1
Matt black	BC589-MB	2TCZ215004R4470	1
Champagne gold	BC589-CH	2TCZ215004R4170	1

Product	Article-No.	Order-No.	Pack/Qty
	<b>Switched Fused connection unit with LED, 13A</b> Rated voltage: 250V AC Rated current: 13A Double pole switch LED indicator		
White	BC507	2TCZ215002R0040	1
Matt white	BC507-WM	2TCZ215002R3940	1
Space grey	BC507-SG	2TCZ215002R6340	1
Matt black	BC507-MB	2TCZ215002R4440	1
Champagne gold	BC507-CH	2TCZ215002R4140	1

	<b>Fused connection unit with LED, 13A</b> Rated voltage: 250V AC Rated current: 13A LED indicator		
White	BC577	2TCZ215003R0040	1
Matt white	BC577-WM	2TCZ215003R3940	1
Space grey	BC577-SG	2TCZ215003R6340	1
Matt black	BC577-MB	2TCZ215003R4440	1
Champagne gold	BC577-CH	2TCZ215003R4140	1

	<b>Flex Outlet 45A</b> Rated voltage: 250V AC Rated current: 45A		
White	BC590	2TCZ215005R0090	1
Matt white	BC590-WM	2TCZ215005R3990	1
Space grey	BC590-SG	2TCZ215005R6390	1
Matt black	BC590-MB	2TCZ215005R4490	1
Champagne gold	BC590-CH	2TCZ215005R4190	1

## Framia

### Accessories

Product	Article-No.	Order-No.	Pack/Qty
---------	-------------	-----------	----------



#### 1 Gang Blank Plate

White	BC504	2TCZ215006R0010	1
Matt white	BC504-WM	2TCZ215006R3910	1
Space grey	BC504-SG	2TCZ215006R6310	1
Matt black	BC504-MB	2TCZ215006R4410	1
Champagne gold	BC504-CH	2TCZ215006R4110	1

Product	Article-No.	Order-No.	Pack/Qty
---------	-------------	-----------	----------

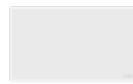

#### 2 Gang Blank Plate

White	BC505	2TCZ215007R0010	1
Matt white	BC505-WM	2TCZ215007R3910	1
Space grey	BC505-SG	2TCZ215007R6310	1
Matt black	BC505-MB	2TCZ215007R4410	1
Champagne gold	BC505-CH	2TCZ215007R4110	1



#### 2 Gang frame

White	BC621	2TCZ215008R0010	1
Matt white	BC621-WM	2TCZ215008R3910	1
Space grey	BC621-SG	2TCZ215008R6310	1
Matt black	BC621-MB	2TCZ215008R4410	1
Champagne gold	BC621-CH	2TCZ215008R4110	1



#### 3 Gang frame

White	BC631	2TCZ215009R0010	1
Matt white	BC631-WM	2TCZ215009R3910	1
Space grey	BC631-SG	2TCZ215009R6310	1
Matt black	BC631-MB	2TCZ215009R4410	1
Champagne gold	BC631-CH	2TCZ215009R4110	1



#### 4 Gang frame

White	BC641	2TCZ215010R0010	1
Matt white	BC641-WM	2TCZ215010R3910	1
Space grey	BC641-SG	2TCZ215010R6310	1
Matt black	BC641-MB	2TCZ215010R4410	1
Champagne gold	BC641-CH	2TCZ215010R4110	1



---

# Zenit British Standard

Switch to endless possibilities

**BL - White**



**PL - Silver**



**AN - Anthracite**

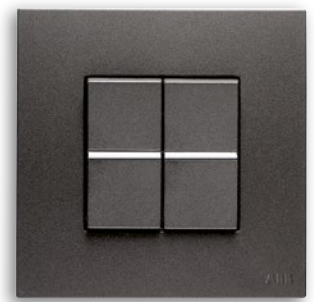

**CV - Champagne**





## Zenit – Complete sets

Switches | Premium size (44 x 44 mm)

Product	Article-No.	Order-No.	Pack/Qty
---------	-------------	-----------	----------



**Switch 1-gang, 1-way,  
SP premium 10AX**  
Rated voltage: 250 Vac  
Rated current: 10AX  
Premium size rocker

White	<b>AM22010 BL</b>	2CLA220109B1101	1
-------	-------------------	-----------------	---



**Switch 1-gang, 2-way,  
SP premium 10AX**  
Rated voltage: 250 Vac  
Rated current: 10AX  
Premium size rocker

White	<b>AM22020 BL</b>	2CLA220209B1101	1
-------	-------------------	-----------------	---



**Switch 1-gang, intermediate,  
SP premium 10AX**  
Rated voltage: 250 Vac  
Rated current: 10AX  
Premium size rocker

White	<b>AM22100 BL</b>	2CLA221009B1101	1
-------	-------------------	-----------------	---



**Switch 1-gang, 1-way,  
SP premium 20AX**  
Rated voltage: 250 Vac  
Rated current: 20AX  
Premium size rocker

White	<b>AM22011 BL</b>	2CLA220119B1101	1
-------	-------------------	-----------------	---



**Push-button 1-gang, 1-way,  
SP premium 10A**  
Rated voltage: 250 Vac  
Rated current: 10A  
Premium size rocker

White	<b>AM22040 BL</b>	2CLA220409B1101	1
-------	-------------------	-----------------	---

Product	Article-No.	Order-No.	Pack/Qty
---------	-------------	-----------	----------



**Switch 1-gang, 2-way, SP 20AX,  
Premium size w / frame**  
Rated voltage: 250 Vac  
Rated current: 20AX  
Function size: 44 x 44 mm  
Includes frame and metal support

White	<b>AM22021 BL</b>	2CLA220219B1101	1
-------	-------------------	-----------------	---



**Switch 1-gang, 1-way, DP 20AX,  
Premium size with LED w / frame**  
Rated voltage: 250 Vac  
Rated current: 20AX  
Function size: 44 x 44 mm  
LED indicator and ON sign  
Includes frame and metal support

White	<b>AM22013 BL</b>	2CLA220139B1101	1
-------	-------------------	-----------------	---



**Switch 1-gang, 1-way, DP 32A,  
Premium size w / frame**  
Rated voltage: 250 Vac  
Rated current: 32A  
Function size: 44 x 44 mm  
Includes frame and metal support with twin-earth

White	<b>AM22018 BL</b>	2CLA220189B1101	1
-------	-------------------	-----------------	---



**Switch 1-gang, 1-way,  
DP premium 45A**  
Rated voltage: 250 Vac  
Rated current: 45A  
Status indicator LED  
Premium size rocker

White	<b>AM22014 BL</b>	2CLA220149B1101	1
-------	-------------------	-----------------	---





**Switch 1-gang, 1-way, SP premium w / bell**  
Rated voltage: 250 Vac  
Rated current: 10A  
Bell symbol indicator LED  
Premium size rocker

White	<b>AM22044 BL</b>	2CLA220449B1101	1
-------	-------------------	-----------------	---

## Zenit – Complete sets

### Socket outlets / Fuse Connection Units

Product	Article-No.	Order-No.	Pack/Qty
	<b>BS Single socket outlet 13A, DP switched</b> Rated voltage: 250 Vac Rated current: 13A Double pole switch Includes child safety shutter Includes frame and metal support with twin earth		
White	AM22373 BL	2CLA223739B1101	1
Silver	AM22373 PL	2CLA223739B1301	1
Anthracite	AM22373 AN	2CLA223739B1801	1
Champagne	AM22373 CV	2CLA223739B1901	1

	<b>BS Single socket outlet 13A, DP switched w / LED</b> Rated voltage: 250 Vac Rated current: 13A Double pole switch LED indicator Includes child safety shutter Includes frame and metal support with twin earth		
White	AM22374 BL	2CLA223749B1101	1
Silver	AM22374 PL	2CLA223749B1301	1
Anthracite	AM22374 AN	2CLA223749B1801	1
Champagne	AM22374 CV	2CLA223749B1901	1

	<b>BS Single socket outlet 13A, with USB-Charger Type-C, DP switch</b> Rated voltage: 250 Vac Rated current: 13A Double pole switch USB-C 18 W. with Advanced Charging Includes child safety shutter Includes frame and metal support with twin earth		
White	AM22379 BL	2CLA223799B1101	1
Silver	AM22379 PL	2CLA223799B1301	1
Anthracite	AM22379 AN	2CLA223799B1801	1
Champagne	AM22379 CV	2CLA223799B1901	1

	<b>BS Cooker control unit 13A, DP sw. 45A</b> Rated voltage: 250 Vac Rated current (socket): 13A Rated current (switch): 45A LED indicator Includes frame and metal support and twin earth		
White	AM24374 BL	2CLA243749B1101	1
Silver	AM24374 PL	2CLA243749B1301	1
Anthracite	AM24374 AN	2CLA243749B1801	1
Champagne	AM24374 CV	2CLA243749B1901	1

	<b>Fuse connector unit 13A, w/flex outlet w/LED</b> Rated voltage: 250 Vac Rated current: 13A LED indicator Fuse breaking capacity: 6kA 264 Vac 50HN Fuse size: Ø 6.3 x 25 mm Includes frame and metal support		
White	AM23085 BL	2CLA230859B1101	1
Silver	AM23085 PL	2CLA230859B1301	1
Anthracite	AM23085 AN	2CLA230859B1801	1
Champagne	AM23085 CV	2CLA230859B1901	1

Product	Article-No.	Order-No.	Pack/Qty
	<b>BS Double socket outlet 13A, DP switched</b> Rated voltage: 250 Vac Rated current: 13A Double pole switch Includes child safety shutter Includes frame and metal support with twin earth		
White	AM24371 BL	2CLA243719B1101	1
Silver	AM24371 PL	2CLA243719B1301	1
Anthracite	AM24371 AN	2CLA243719B1801	1
Champagne	AM24371 CV	2CLA243719B1901	1

	<b>BS Double socket outlet 13A, DP switched w/LED</b> Rated voltage: 250 Vac Rated current: 13A Double pole switch LED indicator Includes child safety shutter Includes frame and metal support with twin earth		
White	AM24372 BL	2CLA243729B1101	1
Silver	AM24372 PL	2CLA243729B1301	1
Anthracite	AM24372 AN	2CLA243729B1801	1
Champagne	AM24372 CV	2CLA243729B1901	1

	<b>BS Double socket outlet 13A, with USB-Charger Type-C+A, DP switch</b> Rated voltage: 250 Vac Rated current: 13A Double pole switch USB-C 18 W. with Advanced Charging USB-A 18 W. (shared) Includes child safety shutter Includes frame and metal support with twin earth		
White	AM24379 BL	2CLA243799B1101	1
Silver	AM24379 PL	2CLA243799B1301	1
Anthracite	AM24379 AN	2CLA243799B1801	1
Champagne	AM24379 CV	2CLA243799B1901	1

	<b>Shaver socket outlet</b> Input: 250 Vac / 20VA Outputs: 115V and 230V Size: 150 x 90 x 54 mm Compatible with box model: 803.2		
White	AM28030 BL	2CLA280309B1101	1
Silver	AM28030 PL	2CLA280309B1301	1
Anthracite	AM28030 AN	2CLA280309B1801	1
Champagne	AM28030 CV	2CLA280309B1901	1

	<b>Fuse connector unit 13A, Switched w/flex outlet w/LED</b> Rated voltage: 250 Vac Rated current: 13A LED indicator Includes manual switch Fuse breaking capacity: 6kA 264 Vac 50HN Fuse size: Ø 6.3 x 25 mm Includes frame and metal support		
White	AM23082 BL	2CLA230829B1101	1
Silver	AM23082 PL	2CLA230829B1301	1
Anthracite	AM23082 AN	2CLA230829B1801	1
Champagne	AM23082 CV	2CLA230829B1901	1

## Zenit - Modular system

### Switches | Small size (22x44 mm)

Product	Article-No.	Order-No.	Pack/Qty
	<b>Switch 1-gang, 1-way, SP 10AX, Small size</b> Rated voltage: 250 Vac Rated current: 10AX Function size: 22x44 mm		
White	<b>AMD21010 BL</b>	2CLA210100B1101	10
Silver	<b>AMD21010 PL</b>	2CLA210100B1301	10
Anthracite	<b>AMD21010 AN</b>	2CLA210100B1801	10
Champagne	<b>AMD21010 CV</b>	2CLA210100B1901	10

	<b>Switch 1-gang, 2-way, SP 10AX, Small size</b> Rated voltage: 250 Vac Rated current: 10AX Function size: 22x44 mm		
White	<b>AMD21020 BL</b>	2CLA210200B1101	10
Silver	<b>AMD21020 PL</b>	2CLA210200B1301	10
Anthracite	<b>AMD21020 AN</b>	2CLA210200B1801	10
Champagne	<b>AMD21020 CV</b>	2CLA210200B1901	10

	<b>Switch 1-gang Intermediate, SP 10AX, Small size</b> Rated voltage: 250 Vac Rated current: 10AX Function size: 22x44 mm		
White	<b>AMD21100 BL</b>	2CLA211000B1101	10
Silver	<b>AMD21100 PL</b>	2CLA211000B1301	10
Anthracite	<b>AMD21100 AN</b>	2CLA211000B1801	10
Champagne	<b>AMD21100 CV</b>	2CLA211000B1901	10

	<b>Switch 1-gang, 1-way, SP 20AX, Small size</b> Rated voltage: 250 Vac Rated current: 20AX Function size: 22x44 mm		
White	<b>AMD21011 BL</b>	2CLA210110B1101	10
Silver	<b>AMD21011 PL</b>	2CLA210110B1301	10
Anthracite	<b>AMD21011 AN</b>	2CLA210110B1801	10
Champagne	<b>AMD21011 CV</b>	2CLA210110B1901	10

	<b>Push button 1-gang, 1-way, SP 10AX, Small size w/ bell</b> Rated voltage: 250 Vac Rated current: 10AX Function size: 22x44 mm LED indicator and bell sign		
White	<b>AMD21044 BL</b>	2CLA210440B1101	10
Silver	<b>AMD21044 PL</b>	2CLA210440B1301	10
Anthracite	<b>AMD21044 AN</b>	2CLA210440B1801	10
Champagne	<b>AMD21044 CV</b>	2CLA210440B1901	10

Product	Article-No.	Order-No.	Pack/Qty
	<b>Switch 1-gang, 2-way, SP 20AX, Small size</b> Rated voltage: 250 Vac Rated current: 20AX Function size: 22x44 mm		
White	<b>AMD21021 BL</b>	2CLA210210B1101	10
Silver	<b>AMD21021 PL</b>	2CLA210210B1301	10
Anthracite	<b>AMD21021 AN</b>	2CLA210210B1801	10
Champagne	<b>AMD21021 CV</b>	2CLA210210B1901	10

	<b>Switch 1-gang, 1-way, DP 20AX, Small size w/ LED</b> Rated voltage: 250 Vac Rated current: 20AX Function size: 22x44 mm LED indicator and ON sign		
White	<b>AMD21013 BL</b>	2CLA210130B1101	10
Silver	<b>AMD21013 PL</b>	2CLA210130B1301	10
Anthracite	<b>AMD21013 AN</b>	2CLA210130B1801	10
Champagne	<b>AMD21013 CV</b>	2CLA210130B1901	10

	<b>Switch 1-gang, 1-way, DP 20AX, Small size w/ LED and Heater symbol</b> Rated voltage: 250 Vac Rated current: 20AX Function size: 22x44 mm LED indicator and WATER HEATER sign		
White	<b>AMD21014 BL</b>	2CLA210140B1101	10
Silver	<b>AMD21014 PL</b>	2CLA210140B1301	10
Anthracite	<b>AMD21014 AN</b>	2CLA210140B1801	10
Champagne	<b>AMD21014 CV</b>	2CLA210140B1901	10

	<b>Push button 1-gang, 1-way, SP 10AX, Small size</b> Rated voltage: 250 Vac Rated current: 10AX Function size: 22x44 mm		
White	<b>AMD21040 BL</b>	2CLA210400B1101	10
Silver	<b>AMD21040 PL</b>	2CLA210400B1301	10
Anthracite	<b>AMD21040 AN</b>	2CLA210400B1801	10
Champagne	<b>AMD21040 CV</b>	2CLA210400B1901	10

## Zenit - Modular system

### Switches | Premium size (44 x 44 mm)

Product	Article-No.	Order-No.	Pack/Qty
---------	-------------	-----------	----------



**Switch 1-gang, 1-way, SP 10AX, Premium size**  
 Rated voltage: 250 Vac  
 Rated current: 10AX  
 Function size: 44 x 44 mm

White	<b>AMD22010 BL</b>	2CLA220100B1101	10
Silver	<b>AMD22010 PL</b>	2CLA220100B1301	10
Anthracite	<b>AMD22010 AN</b>	2CLA220100B1801	10
Champagne	<b>AMD22010 CV</b>	2CLA220100B1901	10



**Switch 1-gang, 2-way, SP 10AX, Premium size**  
 Rated voltage: 250 Vac  
 Rated current: 10AX  
 Function size: 44 x 44 mm

White	<b>AMD22020 BL</b>	2CLA220200B1101	10
Silver	<b>AMD22020 PL</b>	2CLA220200B1301	10
Anthracite	<b>AMD22020 AN</b>	2CLA220200B1801	10
Champagne	<b>AMD22020 CV</b>	2CLA220200B1901	10



**Switch 1-gang Intermediate, SP 10AX, Premium size**  
 Rated voltage: 250 Vac  
 Rated current: 10AX  
 Function size: 44 x 44 mm

White	<b>AMD22100 BL</b>	2CLA221000B1101	10
Silver	<b>AMD22100 PL</b>	2CLA221000B1301	10
Anthracite	<b>AMD22100 AN</b>	2CLA221000B1801	10
Champagne	<b>AMD22100 CV</b>	2CLA221000B1901	10



**Switch 1-gang, 1-way, SP 20AX, Premium size**  
 Rated voltage: 250 Vac  
 Rated current: 20AX  
 Function size: 44 x 44 mm

White	<b>AMD22011 BL</b>	2CLA220110B1101	10
Silver	<b>AMD22011 PL</b>	2CLA220110B1301	10
Anthracite	<b>AMD22011 AN</b>	2CLA220110B1801	10
Champagne	<b>AMD22011 CV</b>	2CLA220110B1901	10



**Switch 1-gang, 1-way, DP 45A, Premium size w/ LED**  
 Rated voltage: 250 Vac  
 Rated current: 45A  
 Function size: 44 x 44 mm  
 LED indicator

White	<b>AMD22014 BL</b>	2CLA220140B1101	10
Red	<b>AMD22014 RJ</b>	2CLA220140B7001	10

Product	Article-No.	Order-No.	Pack/Qty
---------	-------------	-----------	----------



**Switch 1-gang, 2-way, SP 20AX, Premium size**  
 Rated voltage: 250 Vac  
 Rated current: 20AX  
 Function size: 44 x 44 mm

White	<b>AMD22021 BL</b>	2CLA220210B1101	10
Silver	<b>AMD22021 PL</b>	2CLA220210B1301	10
Anthracite	<b>AMD22021 AN</b>	2CLA220210B1801	10
Champagne	<b>AMD22021 CV</b>	2CLA220210B1901	10



**Switch 1-gang, 1-way, DP 20AX, Premium size w/ LED**  
 Rated voltage: 250 Vac  
 Rated current: 20AX  
 Function size: 44 x 44 mm  
 LED indicator and ON sign

White	<b>AMD22013 BL</b>	2CLA220130B1101	10
Silver	<b>AMD22013 PL</b>	2CLA220130B1301	10
Anthracite	<b>AMD22013 AN</b>	2CLA220130B1801	10
Champagne	<b>AMD22013 CV</b>	2CLA220130B1901	10



**Switch 1-gang, 1-way, DP 20AX, Premium size w/ LED and Heater symbol**  
 Rated voltage: 250 Vac  
 Rated current: 20AX  
 Function size: 44 x 44 mm  
 LED indicator and WATER HEATER sign

White	<b>AMD22015 BL</b>	2CLA220150B1101	10
Silver	<b>AMD22015 PL</b>	2CLA220150B1301	10
Anthracite	<b>AMD22015 AN</b>	2CLA220150B1801	10
Champagne	<b>AMD22015 CV</b>	2CLA220150B1901	10





**Switch 1-gang, 1-way, DP 32A, Premium size**  
 Rated voltage: 250 Vac  
 Rated current: 32A  
 Function size: 44 x 44 mm

White	<b>AMD22018 BL</b>	2CLA220180B1101	10
Silver	<b>AMD22018 PL</b>	2CLA220180B1301	10
Anthracite	<b>AMD22018 AN</b>	2CLA220180B1801	10
Champagne	<b>AMD22018 CV</b>	2CLA220180B1901	10

## Zenit - Modular System

Push button | Premium size (44x44 mm)

Product	Article-No.	Order-No.	Pack/Qty
	<b>Switch 3-gang, 2-way, SP 10AX, Triple size</b> Rated voltage: 250 Vac Rated current: 10AX Function size: 53x44 mm		
White	<b>AMD23020 BL</b>	2CLA230200B1101	10
Silver	<b>AMD23020 PL</b>	2CLA230200B1301	10
Anthracite	<b>AMD23020 AN</b>	2CLA230200B1801	10
Champagne	<b>AMD23020 CV</b>	2CLA230200B1901	10

	<b>Switch 3-gang, 2-way, SP 16AX, Triple size</b> Rated voltage: 250 Vac Rated current: 16AX Function size: 53x44 mm		
White	<b>AMD23021 BL</b>	2CLA230210B1101	10
Silver	<b>AMD23021 PL</b>	2CLA230210B1301	10
Anthracite	<b>AMD23021 AN</b>	2CLA230210B1801	10
Champagne	<b>AMD23021 CV</b>	2CLA230210B1901	10

	<b>Push button 1-gang, 1-way, SP 10AX, Premium size</b> Rated voltage: 250 Vac Rated current: 10AX Function size: 44x44 mm		
White	<b>AMD22040 BL</b>	2CLA220400B1101	10
Silver	<b>AMD22040 PL</b>	2CLA220400B1301	10
Anthracite	<b>AMD22040 AN</b>	2CLA220400B1801	10
Champagne	<b>AMD22040 CV</b>	2CLA220400B1901	10

Product	Article-No.	Order-No.	Pack/Qty
	<b>Push button 3-gang, 1-way, SP 10AX, Triple size</b> Rated voltage: 250 Vac Rated current: 10AX Function size: 53x44 mm		
White	<b>AMD23040 BL</b>	2CLA230400B1101	10
Silver	<b>AMD23040 PL</b>	2CLA230400B1301	10
Anthracite	<b>AMD23040 AN</b>	2CLA230400B1801	10
Champagne	<b>AMD23040 CV</b>	2CLA230400B1901	10

	<b>Push button 1-gang, 1-way, SP 10AX, Premium size</b> Rated voltage: 250 Vac Rated current: 10AX Function size: 44x44 mm LED indicator and bell sign		
White	<b>AMD22044 BL</b>	2CLA220440B1101	10
Silver	<b>AMD22044 PL</b>	2CLA220440B1301	10
Anthracite	<b>AMD22044 AN</b>	2CLA220440B1801	10
Champagne	<b>AMD22044 CV</b>	2CLA220440B1901	10

## Zenit - Modular system

### Frames including metal support

Product	Article-No.	Order-No.	Pack/Qty	
	<b>Frame 1-gang – Window 22x44 -Single</b> Frame dimensions: 86x86 mm Window size: 22x44 mm Includes metal support and screws Extra robustness for Small switches (single function only)			
	White	<b>AMD21710 BL</b>	2CLA217100B1101	10
	Silver	<b>AMD21710 PL</b>	2CLA217100B1301	10
	Anthracite	<b>AMD21710 AN</b>	2CLA217100B1801	10
	Champagne	<b>AMD21710 CV</b>	2CLA217100B1901	10

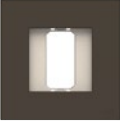
	<b>Frame 1-gang – Window 44x44 -Single</b> Frame dimensions: 86x86 mm Window size: 44x44 mm Includes metal support and screws Extra robustness for Premium switches (single function only)			
	White	<b>AMD21711 BL</b>	2CLA217110B1101	10
	Silver	<b>AMD21711 PL</b>	2CLA217110B1301	10
	Anthracite	<b>AMD21711 AN</b>	2CLA217110B1801	10
	Champagne	<b>AMD21711 CV</b>	2CLA217110B1901	10

	<b>Frame 1-gang – Window 44x44 -Multifunction</b> Frame dimensions: 86x86 mm Window size: 44x44 mm Includes metal support and screws For multiple function configurations			
	White	<b>AMD22710 BL</b>	2CLA227100B1101	10
	Silver	<b>AMD22710 PL</b>	2CLA227100B1301	10
	Anthracite	<b>AMD22710 AN</b>	2CLA227100B1801	10
	Champagne	<b>AMD22710 CV</b>	2CLA227100B1901	10

	<b>Frame 1-gang – Window 53x44</b> Frame dimensions: 86x86 mm Window size: 53x44 mm Includes metal support and screws For Triple rocker switches			
	White	<b>AMD23710 BL</b>	2CLA237100B1101	10
	Silver	<b>AMD23710 PL</b>	2CLA237100B1301	10
	Anthracite	<b>AMD23710 AN</b>	2CLA237100B1801	10
	Champagne	<b>AMD23710 CV</b>	2CLA237100B1901	10

Product	Article-No.	Order-No.	Pack/Qty	
	<b>Frame 2-gang – Window 44x44 – Multifunction</b> Frame dimensions: 147x86 mm Window size: 2*44x44 mm Includes metal support and screws For multiple function configurations			
	White	<b>AMD24720 BL</b>	2CLA247200B1101	10
	Silver	<b>AMD24720 PL</b>	2CLA247200B1301	10
	Anthracite	<b>AMD24720 AN</b>	2CLA247200B1801	10
	Champagne	<b>AMD24720 CV</b>	2CLA247200B1901	10

	<b>Frame 2-gang – Window 53x44</b> Frame dimensions: 147x86 mm Window size: 2*53x44 mm Includes metal support and screws For Triple rocker switches			
	White	<b>AMD26720 BL</b>	2CLA267200B1101	10
	Silver	<b>AMD26720 PL</b>	2CLA267200B1301	10
	Anthracite	<b>AMD26720 AN</b>	2CLA267200B1801	10
	Champagne	<b>AMD26720 CV</b>	2CLA267200B1901	10

	<b>Frame 3-gang –Window 44x44 – Multifunction</b> Frame dimensions: 228x86 mm Window size: 3*44x44 mm Includes metal support and screws For multiple function configurations Compatible with box model: 1099			
	White	<b>AMD26731 BL</b>	2CLA267310B1101	5
	Silver	<b>AMD26731 PL</b>	2CLA267310B1301	5
	Anthracite	<b>AMD26731 AN</b>	2CLA267310B1801	5
	Champagne	<b>AMD26731 CV</b>	2CLA267310B1901	5

	<b>Frame 4-gang – Window 44x44 – Multifunction</b> Frame dimensions: 293x86 mm Window size: 4*44x44 mm Includes metal support and screws For multiple function configurations Compatible with box model: 1099			
	White	<b>AMD28741 BL</b>	2CLA287410B1101	5
	Silver	<b>AMD28741 PL</b>	2CLA287410B1301	5
	Anthracite	<b>AMD28741 AN</b>	2CLA287410B1801	5
	Champagne	<b>AMD28741 CV</b>	2CLA287410B1901	5

## Zenit - Modular system

Frames with metal support and twin earth terminals

Product	Article-No.	Order-No.	Pack/Qty
	<b>Frame 1-gang –Window 44 x 44 –Twin-Earth</b> Frame dimensions: 86x86 mm Window size: 44x44 mm Includes metal support with twin-earth terminals and screws.		
White	<b>AMD22712 BL</b>	2CLA227120B1101	10
Silver	<b>AMD22712 PL</b>	2CLA227120B1301	10
Anthracite	<b>AMD22712 AN</b>	2CLA227120B1801	10
Champagne	<b>AMD22712 CV</b>	2CLA227120B1901	10

	<b>Frame 1-gang –Window 44 x 44 – Twin-Earth Large size</b> Frame dimensions: 86x147 mm Window size: 44x44 mm Includes metal support with twin-earth terminals and screws.		
White	<b>AMD22716 BL</b>	2CLA227160B1101	10
Silver	<b>AMD22716 PL</b>	2CLA227160B1301	10
Anthracite	<b>AMD22716 AN</b>	2CLA227160B1801	10
Champagne	<b>AMD22716 CV</b>	2CLA227160B1901	10



### Pro tip: Twin-earth terminals

Special frames are available including two earth terminals in the mounting frame. This is an easy and quick solution for installations where high amperage devices (32A, 45A) might require more room to connect earth wires.

## Frame adapters

Product	Article-No.	Order-No.	Pack/Qty
	<b>1-gang spacer for BS boxes</b> +7 mm spacer to increase clearance in BS 4662 installation boxes. PC material		
White	<b>AMD5086 BL</b>	2CLA625009B1101	10
Anthracite P.	<b>AMD5086 AP</b>	2CLA625009B1001	10
Black	<b>AMD5086 NG</b>	2CLA625009B1501	10

	<b>2-gang spacer for BS boxes</b> +7 mm spacer to increase clearance in BS 4662 installation boxes. PC material		
White	<b>AMD50147 BL</b>	2CLA645009B1101	10
Anthracite P.	<b>AMD50147 AP</b>	2CLA645009B1001	10
Black	<b>AMD50147 NG</b>	2CLA645009B1501	10



### Pro tip: Spacers

7 mm frame adapters are available to increase the clearance for wires in installation boxes.

This can turn a standard box into a deeper box without needing to do any cosmetic works.

## Zenit - Modular system

Function | Socket outlets & Fuse connection unit

Product	Article-No.	Order-No.	Pack/Qty
	<b>Insert - Modular BS socket outlet</b> Rated voltage: 250 Vac Rated current: 13A Type G: 2P + E Includes child safety shutter Combine with frame window 44 x 44 – Multi		
White	<b>N2237 BL</b>	2CLA223700B1101	10
Silver	<b>N2237 PL</b>	2CLA223700B1301	10
Anthracite	<b>N2237 AN</b>	2CLA223700B1801	10
Champagne	<b>N2237 CV</b>	2CLA223700B1901	10

	<b>Insert - Modular Universal socket outlet</b> Rated voltage: 250 Vac / 125 Vac Rated current: 16A / 13A Multiple type: 2P + E Includes child safety shutter Combine with frame window 44 x 44 – Multi		
White	<b>N2239 BL</b>	2CLA223900B1101	10
Silver	<b>N2239 PL</b>	2CLA223900B1301	10
Anthracite	<b>N2239 AN</b>	2CLA223900B1801	10
Champagne	<b>N2239 CV</b>	2CLA223900B1901	10

Product	Article-No.	Order-No.	Pack/Qty
	<b>Flex Outlet 45A</b> Rated current: 45A Includes frame and metal support with twin earth		
<b>Colour</b>	<b>Type</b>	<b>Order code</b>	<b>Pack/Qty.</b>
Anthracite	<b>AM56086 AP</b>	2CLA620739N1801	1
White Plastic	<b>AM56086 BL</b>	2CLA620739N2001	1

	<b>Flex Outlet 20A</b> Rated current: 20A Combine with frame window 44 x 44 –Twin earth		
<b>Colour</b>	<b>Type</b>	<b>Order code</b>	<b>Pack/Qty.</b>
Anthracite	<b>AMD22072 AP</b>	2CLA220729B1001	10
White	<b>AMD22072 BL</b>	2CLA220729B1101	10

## Zenit - Modular system

### Function | USB chargers

#### USB charger Type A+C 18W - 44 x 44



250 Vac / 50-60 Hz

USB-C:  
Max. Power output: 18W  
Output voltage: 5 ... 9 Vdc.  
Output current: 3 ... 1.5 A.

USB-A: 5 Vdc (max. 2,1 A).  
USB-A+C simultaneously: 5 Vdc (max. .3 A)

Charging Protocols:  
PD 3.0, QC 4.0, QC 3.0, QC 2.0, MFi 2,4A, BC 1.2,

Frame AMD5144-XX & AMD5244-XX.

Colour	Type	Order code	Pack/Qty.
White	<b>N2285.1 BL</b>	2CLA228510B1101	1
Silver	<b>N2285.1 PL</b>	2CLA228510B1301	1
Anthracite	<b>N2285.1 AN</b>	2CLA228510B1801	1
Champagne	<b>N2285.1 CV</b>	2CLA228510B1901	1

#### USB charger Type A+C 15W - 44 x 44



250 Vac / 50-60 Hz

USB-A: 5 Vdc (max. 2,4 A).  
USB-C: 5 Vdc (max. 3 A).  
USB-A+C simultaneously: 5 Vdc (total max .3 A)

Charging Protocols:  
USB-C, DFP 5V/3A, MFi 2,4A, BC 1.2, DCP 5V/1,5A

Frame AMD5144-XX & AMD5244-XX.

Colour	Type	Order code	Pack/Qty.
White	<b>N2285.4 BL</b>	2CLA228540B1101	1
Silver	<b>N2285.4 PL</b>	2CLA228540B1301	1
Anthracite	<b>N2285.4 AN</b>	2CLA228540B1801	1
Champagne	<b>N2285.4 CV</b>	2CLA228540B1901	1

#### USB charger Type C+C 30W - 44 x 44



250 Vac / 50-60 Hz

USB-C:  
Max. Power output: 30W  
Output voltage: 5 ... 20 Vdc.  
Output current: 3 ... 1.5 A.

USB C+C simultaneously:  
Max Power output: 15 W  
Output voltage: 5 Vdc  
Output current: 2.1 A

Charging Protocols:  
PD 3.0, QC 4.0, QC 3.0, QC 2.0, MFi 2,4A, BC 1.2,

Frame AMD5144-XX & AMD5244-XX.

Colour	Type	Order code	Pack/Qty.
White	<b>N2285.5 BL</b>	2CLA228550B1101	1
Silver	<b>N2285.5 PL</b>	2CLA228550B1301	1
Anthracite	<b>N2285.5 AN</b>	2CLA228550B1801	1
Champagne	<b>N2285.5 CV</b>	2CLA228550B1901	1

#### USB charger Type A+C 15W - 22 x 44



250 Vac / 50-60 Hz

USB-A: 5 Vdc (max. 2,4 A).  
USB-C: 5 Vdc (max. 3 A).  
USB-A+C simultaneously: 5 Vdc (total max .3 A)

Charging Protocols:  
USB-C, DFP 5V/3A, MFi 2,4A, BC 1.2, DCP 5V/1,5A

Frame AMD5144-XX & AMD5244-XX.

Colour	Type	Order code	Pack/Qty.
White	<b>N2185.4 BL</b>	2CLA218540B1101	1
Silver	<b>N2185.4 PL</b>	2CLA218540B1301	1
Anthracite	<b>N2185.4 AN</b>	2CLA218540B1801	1
Champagne	<b>N2185.4 CV</b>	2CLA218540B1901	1

## Zenit - Modular system

### Function | Dimmers

Product	Article-No.	Order-No.	Pack/Qty
---------	-------------	-----------	----------



#### Universal rotary dimmer – 1M

Rated voltage: 230 Vac  $\pm$  10%  
 Frequency: 50-60Hz  
 Power (min./max load):  
 - LEDi (trailing-edge lamps), LV LEDi with transformer type C, LV halogen with transformer (type C or LC) and incandescent and halogen lamps: 4/250 W/VA.  
 - LEDi (leading-edge lamps) and LV LEDi with transformer type LC: 4/60W/VA\*  
 \* Max. 10 lamps  
 Load selection  
 2 or 3 wire connection  
 OFF position  
 Electronic back-up fuse and overload protection  
 Ambient temperature: 0° C to +35° C

White	<b>N2160.3 BL</b>	2CLA216030B1101	1
Silver	<b>N2160.3 PL</b>	2CLA216030B1301	1
Anthracite	<b>N2160.3 AN</b>	2CLA216030B1801	1
Champagne	<b>N2160.3 CV</b>	2CLA216030B1901	1

Product	Article-No.	Order-No.	Pack/Qty
---------	-------------	-----------	----------



#### Universal rotary dimmer – 2M

Rated voltage: 230 Vac  $\pm$  10%  
 Frequency: 50Hz (250W/VA) / 60Hz (200W/VA)  
 Power (min./max load):  
 - LEDi, dimmable CFL and LV LEDi with transformer (L or LC): 2/100W/VA\*  
 - Incandescent and halogen lamps: 10/250W/VA  
 - LV halogen w/transformer (L or LC): 10/250W/VA\*  
 \* max. 10 lamps  
 2 wire connection  
 Optional: auxiliary on/off with 2-way switch N2X02  
 Indicator LED lamp included  
 Electronic back-up fuse and overload protection  
 Ambient temperature 0° C to +35° C

White	<b>N2260.3 BL</b>	2CLA226030B1101	1
Silver	<b>N2260.3 PL</b>	2CLA226030B1301	1
Anthracite	<b>N2260.3 AN</b>	2CLA226030B1801	1
Champagne	<b>N2260.3 CV</b>	2CLA226030B1901	1



#### 1-10V rotary dimmer - 2M

Rated voltage: 127 - 230 Vac / 50-60Hz  
 Dimmable electronic ballast/driver 1-10V control input.  
 Max. power (max. 6 ballasts per device):  
 700 VA @ 230 Vac / 350 VA @ 127 Vac  
 Indicator LED lamp included.

White	<b>N2260.9 BL</b>	<b>2CLA226090B1101</b>	1
Silver	<b>N2260.9 PL</b>	<b>2CLA226090B1301</b>	1
Anthracite	<b>N2260.9 AN</b>	<b>2CLA226090B1801</b>	1
Champagne	<b>N2260.9 CV</b>	<b>2CLA226090B1901</b>	1

### Function | Blank plates



#### Blank cover plate – 1M

Flat blank plate

Combine with any 22x44 or 44x44 multi frames

White	<b>N2100 BL</b>	2CLA210000B1101	1
Silver	<b>N2100 PL</b>	2CLA210000B1301	1
Anthracite	<b>N2100 AN</b>	2CLA210000B1801	1
Champagne	<b>N2100 CV</b>	2CLA210000B1901	1



#### Blank cover plate – 2M

Flat blank plate

Combine with any 22x44 or 44x44 multi frames

White	<b>N2200 BL</b>	2CLA220000B1101	1
Silver	<b>N2200 PL</b>	2CLA220000B1301	1
Anthracite	<b>N2200 AN</b>	2CLA220000B1801	1
Champagne	<b>N2200 CV</b>	2CLA220000B1901	1

## Zenit - Modular system

### Function | Hospitality

Product	Article-No.	Order-No.	Pack/Qty
---------	-------------	-----------	----------



#### DND/MUR corridor unit 10AX

Rated voltage: 250 Vac  
Rated current: 10AX  
Includes red / green indication and bell sign  
Function size: 44 x 44 mm  
Combine with frame window 44 x 44 – Multi.

White	<b>N2280.4 BL</b>	2CLA228040B1101	10
Silver	<b>N2280.4 PL</b>	2CLA228040B1301	10
Anthracite	<b>N2280.4 AN</b>	2CLA228040B1801	10
Champagne	<b>N2280.4 CV</b>	2CLA228040B1901	10



#### DND/MUR room unit 16AX

Rated voltage: 250 Vac  
Rated current: 16AX  
Interlocked gangs  
Time-saving screwless connection  
Includes red / green indication and bell sign  
Function size: 44 x 44 mm  
Combine with frame window 44 x 44 – Multi.

White	<b>N2244.4 BL</b>	2CLA224440B1101	10
Silver	<b>N2244.4 PL</b>	2CLA224440B1301	10
Anthracite	<b>N2244.4 AN</b>	2CLA224440B1801	10
Champagne	<b>N2244.4 CV</b>	2CLA224440B1901	10



#### Blind control switch 16AX

Rated voltage: 250 Vac  
Rated current: 16AX  
Direct control of blind motor  
Interlocked gangs  
Combine with frame window 44 x 44 – Multi.

White	<b>N2244.1 BL</b>	2CLA224410B1101	10
Silver	<b>N2244.1 PL</b>	2CLA224410B1301	10
Anthracite	<b>N2244.1 AN</b>	2CLA224410B1801	10
Champagne	<b>N2244.1 CV</b>	2CLA224410B1901	10

Product	Article-No.	Order-No.	Pack/Qty
---------	-------------	-----------	----------



#### Card switch 16AX

Rated voltage: 250 Vac  
Rated current: 16AX  
Max. power: iLED 200W.  
Includes LED indicator  
Function size: 44 x 44 mm  
Combine with frame window 44 x 44 – Multi.

White	<b>N2214.1 BL</b>	2CLA221410B1101	10
Silver	<b>N2214.1 PL</b>	2CLA221410B1301	10
Anthracite	<b>N2214.1 AN</b>	2CLA221410B1801	10
Champagne	<b>N2214.1 CV</b>	2CLA221410B1901	10



#### Electronic Card switch 16AX w/timer

Rated voltage: 250 Vac  
Rated current: 16AX  
Max. power: iLED200W / Traditional: 1600W  
Includes LED indicator  
Adjustable time-out: 5-90 seg.  
Function size: 44 x 44 mm  
Combine with frame window 44 x 44 – Multi.

White	<b>N2214.5 BL</b>	2CLA221450B1101	1
Silver	<b>N2214.5 PL</b>	2CLA221450B1301	1
Anthracite	<b>N2214.5 AN</b>	2CLA221450B1801	1
Champagne	<b>N2214.5 CV</b>	2CLA221450B1901	1



#### Electronic Card switch 16AX w/RFID

250 Vac 50-60 HN. /16A  
Rated voltage: 110 ... 230 V AC, ±10 %, RFID card-only option:Yes  
4 programming modes:  
ECO, STANDARD, EXTENDED, CUSTOM  
Status backlight: Yes  
Dim-out deactivation: Yes  
Adjustable time-out: 0-240 seg.  
Output: 2\*NO cotact  
Electronic relay: Yes  
Load compatibility (min. / max load):  
-LEDi: 250 W/VA.  
-LV LEDi with transformer type C: 4 / 250 W/VA.  
-LV LEDi with transformer type LC: 4 / 60 W/VA.\*  
-LV halogen with transformer type C: 4 / 250 W/VA.  
-LV halogen with transformer type LC: 4 / 250 W/VA.  
-Incandescent lamps: 4 / 250 W/VA.  
-Halogen lamps: 4 / 250 W /VA.  
-Blind control (M-type) max. 2 Aem

Combine with frame window 44 x 44 – Multi.

White	<b>N2214.6 BL</b>	2CLA221460B1101	1
Silver	<b>N2214.6 PL</b>	2CLA221460B1301	1
Anthracite	<b>N2214.6 AN</b>	2CLA221460B1801	1
Champagne	<b>N2214.6 CV</b>	2CLA221460B1901	1

## Zenit - Modular system

### Function I TV/SAT outlets

Color	Article-No.	Order-No.	Pack/Qty
	<b>TV outlet M-type - 22x44</b> Single TV outlet - Dead-end M type - 9.52 mm male For 75Ω impedance coaxial cable Avoid small bending radius Frequency range: 5 - 2.400 Mhz Connection loss: 1 dB Isolation: >16 dB Return loss: >7,6 dB DC path (Vdc / mA / Tono): 34 max. / 500 max. / 22kHz- DiSEqC Combine with any 22 x 44 or 44 x 44 multi frames		
White	<b>N2150.7 BL</b>	2CLA215070B1101	10
Silver	<b>N2150.7 PL</b>	2CLA215070B1301	10
Anthracite	<b>N2150.7 AN</b>	2CLA215070B1801	10
Champagne	<b>N2150.7 CV</b>	2CLA215070B1901	10

	<b>TV/SAT outlet F-type screw-in 22 x 44</b> Single TV outlet F type - female For 75 Ω impedance coaxial cable Frequency range: 0 - 2.0 Working voltage: 250 VRMS max. 00 Mhz Dielectric withstanding voltage: 500 VRMS min.  Combine with any 22 x 44 or 44 x 44 multi frames		
White	<b>N2150 BL</b>	2CLA215000B1101	10
Silver	<b>N2150 PL</b>	2CLA215000B1301	10
Anthracite	<b>N2150 AN</b>	2CLA215000B1801	10
Champagne	<b>N2150 CV</b>	2CLA215000B1901	10

	<b>TV outlet M-type + SAT F-Type dead-end 22 x 44</b> Single TV outlet - Dead end - TV: M type - 9.52 mm male - SAT: F type - female For 75 Ω impedance coaxial cable Frequency range (TV / SAT): 5 - 862 Mhz / 950 - 2.400 MHz Output loss (TV / SAT): 1dB/1dB Through loss (TV / SAT): 4dB/4dB DC path (Vdc / mA / Tono): 34 max. / 500 max. / 22kHz - DiSEqC.		
White	<b>N2151.7 BL</b>	2CLA215170B1101	10
Silver	<b>N2151.7 PL</b>	2CLA215170B1301	10
Anthracite	<b>N2151.7 AN</b>	2CLA215170B1801	10
Champagne	<b>N2151.7 CV</b>	2CLA215170B1901	10

Color	Article-No.	Order-No.	Pack/Qty
	<b>TV M-type 44 x 44</b> Single TV outlet - Dead-end M type - 9.52 mm. male For 75Ω impedance coaxial cable Avoid small bending radius Frequency range: 5 - 2.400 Mhz Connection loss: 1 dB Isolation: >16 dB Return loss: >7.6 dB DC path (Vdc / mA / Tono): 34 max. / 500 max. / 22kHz- DiSEqC Combine with 44x44 multi frames		
White	<b>N2250.7 BL</b>	2CLA225070B1101	10
Silver	<b>N2250.7 PL</b>	2CLA225070B1301	10
Anthracite	<b>N2250.7 AN</b>	2CLA225070B1801	10
Champagne	<b>N2250.7 CV</b>	2CLA225070B1901	10

	<b>TV/SAT F-type screw-in 44 x 44</b> Single TV outlet F type - female For 75 Ω impedance coaxial cable Frequency range: 0 - 2.000 Mhz Working voltage: 250 VRMS max. Dielectric withstanding voltage: 500 VRMS min.  Combine with 44 x 44 multi frames		
White	<b>N2250 BL</b>	2CLA225000B1101	10
Silver	<b>N2250 PL</b>	2CLA225000B1301	10
Anthracite	<b>N2250 AN</b>	2CLA225000B1801	10
Champagne	<b>N2250 CV</b>	2CLA225000B1901	10

	<b>TV outlet M-type + SAT F-Type intermediate 22 x 44</b> Single TV outlet - intermediate - TV: M type - 9.52 mm male - SAT: F type - female For 75 Ω impedance coaxial cable Frequency range (TV / SAT): 5 - 862 Mhz / 950 - 2.400 MHz. Output loss (TV / SAT): 1 dB / 1 dB. DC path (Vdc / mA / Tono): 34 max. / 500 max. / 22kHz - DiSEqC..  Combine with any 22x44 or 44x44 multi frames		
White	<b>N2151.7 BL</b>	2CLA215180B1101	10
Silver	<b>N2151.7 PL</b>	2CLA215180B1301	10
Anthracite	<b>N2151.7 AN</b>	2CLA215180B1801	10
Champagne	<b>N2151.7 CV</b>	2CLA215180B1901	10

## Zenit - Modular system

### Function I Data and telephone outlets

Color	Article-No.	Order-No.	Pack/Qty
 <p><b>Data outlet RJ45 Cat6A 22x44</b> 8 pole Cat 6A STP Combine with any 22x44 or 44x44 multi frames</p>			
White	<b>N2118.7 BL</b>	2CLA211870B1101	10
Silver	<b>N2118.7 PL</b>	2CLA211870B1301	10
Anthracite	<b>N2118.7 AN</b>	2CLA211870B1801	10
Champagne	<b>N2118.7 CV</b>	2CLA211870B1901	10

 <p><b>Data outlet RJ45 Cat6 22x44</b> 8 pole Cat 6 UTP Combine with any 22x44 or 44x44 multi frames</p>			
White	<b>N2118.6 BL</b>	2CLA211860B1101	10
Silver	<b>N2118.6 PL</b>	2CLA211860B1301	10
Anthracite	<b>N2118.6 AN</b>	2CLA211860B1801	10
Champagne	<b>N2118.6 CV</b>	2CLA211860B1901	10

 <p><b>Phone outlet RJ12 22x44</b> RJ12 type connection 6 contacts Combine with any 22x44 or 44x44 multi frames</p>			
White	<b>N2117.6 BL</b>	2CLA211760B1101	10
Silver	<b>N2117.6 PL</b>	2CLA211760B1301	10
Anthracite	<b>N2117.6 AN</b>	2CLA211760B1801	10
Champagne	<b>N2117.6 CV</b>	2CLA211760B1901	10

Color	Article-No.	Order-No.	Pack/Qty
 <p><b>Data outlet RJ45 Cat 6A 44x44</b> 8 pole Cat 6A STP Combine with 44x44 multi frames</p>			
White	<b>N2218.7 BL</b>	2CLA221870B1101	10
Silver	<b>N2218.7 PL</b>	2CLA221870B1301	10
Anthracite	<b>N2218.7 AN</b>	2CLA221870B1801	10
Champagne	<b>N2218.7 CV</b>	2CLA221870B1901	10

 <p><b>Data outlet RJ45 Cat6 44x44</b> 8 pole Cat 6 UTP Combine with 44x44 multi frames</p>			
White	<b>N2218.6 BL</b>	2CLA221860B1101	10
Silver	<b>N2218.6 PL</b>	2CLA221860B1301	10
Anthracite	<b>N2218.6 AN</b>	2CLA221860B1801	10
Champagne	<b>N2218.6 CV</b>	2CLA221860B1901	10

 <p><b>Phone outlet RJ12 44x44</b> RJ12 type connection 6 contacts Combine with 44x44 multi frames</p>			
White	<b>N2217.6 BL</b>	2CLA221760B1101	10
Silver	<b>N2217.6 PL</b>	2CLA221760B1301	10
Anthracite	<b>N2217.6 AN</b>	2CLA221760B1801	10
Champagne	<b>N2217.6 CV</b>	2CLA221760B1901	10



# Metal Clad

Surface mounted wiring devices



## Benefits & features



- Manufactured from high quality steel with good aesthetics



- Designed to withstand everyday knocks and scrapes



- The durable and tough finish is further enhanced by a superb protective coating to stand up to arduous duty and environment



- Designed for easy mounting and installations

# Product overview

## Switches

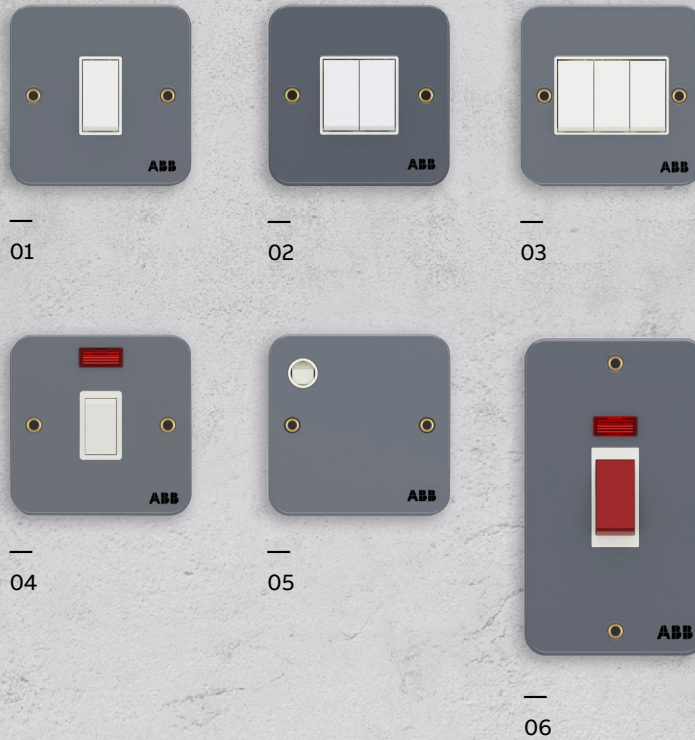

See product picture	Order Code	Type	Description	Technical Data	Surface-mounted Box Dimension
<b>Switches</b>					
01	2TCZ741004R0030	BM101	1Gang 1Way 10AX Switch	10AX	40mm
01	2TCZ741005R0030	BM105	1Gang 2Way 10AX Switch	10AX	40mm
01	2TCZ741010R0030	BM119	1Gang 10AX Intermediate Switch	10AX	40mm
01	2TCZ741011R0030	BM430	1Gang 1Way 10A Push Switch	10A	40mm
02	2TCZ741006R0030	BM102	2Gang 1Way 10AX Switch	10AX	40mm
02	2TCZ741007R0030	BM106	2Gang 2Way 10AX Switch	10AX	40mm
03	2TCZ741008R0030	BM103	3Gang 1Way 10AX Switch	10AX	40mm
03	2TCZ741009R0030	BM107	3Gang 2Way 10AX Switch	10AX	40mm
04	2TCZ741012R0070	BM171	1Gang 20A DP Switch with Neon	20A	40mm
05	2TCZ741014R0070	BM120	20A Connection unit with Flex outlet	20A	40mm
06	2TCZ741013R0090	BM177	1Gang 45A DP Switch with Neon (6 x 3)	45A	40mm

Note: all wiring devices are supplied with backboxes.

# Socket & Data outlets FCU & Flex outlets/Accessories

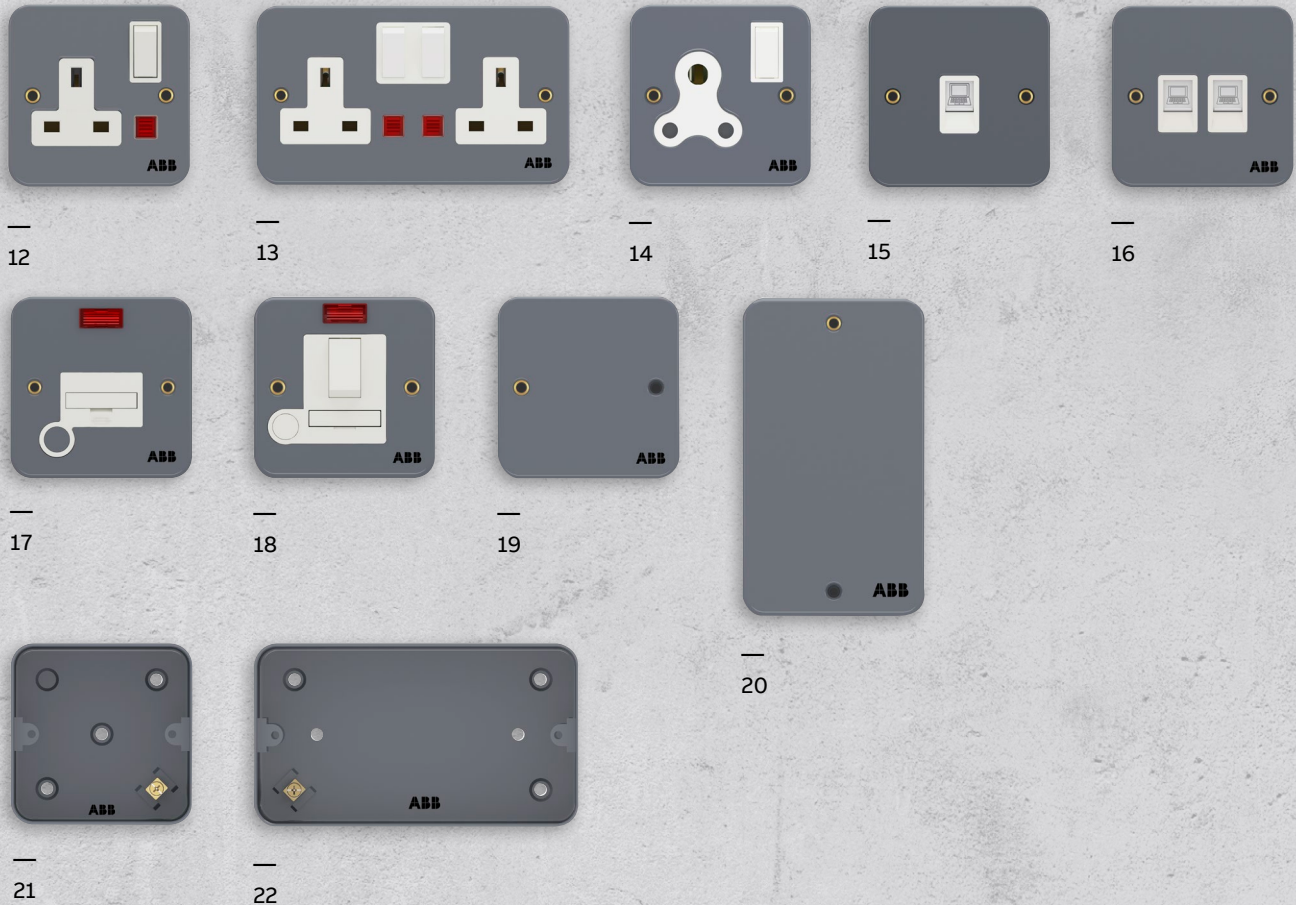

See product picture	Order Code	Type	Description	Technical Data	Surface-mounted Box Dimension
<b>Socket &amp; Data outlets/FCU &amp; Flex outlet/Accessories</b>					
12	2TCZ742001R0040	BM238	1Gang 13A Switched Socket DP with Neon	13A	40mm
13	2TCZ742002R0040	BM240	2Gang 13A Switched Socket DP with Neon	13A	40mm
14	2TCZ742003R0050	BM209	1Gang 15A Switched Socket SP	15A	40mm
15	2TCZ743001R0010	BM333	1Gang Data outlet, Cat.6	RJ45	40mm
16	2TCZ743002R0010	BM329	2Gang Data outlet, Cat.6	RJ45	40mm
17	2TCZ745001R0040	BM577	1Gang 13A Unswitched fused connection unit with Neon	13A	40mm
18	2TCZ745002R0040	BM507	1Gang 13A Switched fused connection unit with Neon	13A	40mm
19	2TCZ745003R0010	BM504	1Gang Blank plate	-	-
20	2TCZ745004R0010	BM505	2Gang Blank plate	-	-
21	2TCZ745005R0010	BM541	1Gang Metal mounting box	-	40mm
22	2TCZ745006R0010	BM542	2Gang Metal mounting box	-	40mm

Note: all wiring devices are supplied with backboxes.

---

# Weatherproof Switches and Socket Outlets



## Weatherproof Switched Isolator IP66



### Range features:

- Degree of protection IP66 prevents dust and powerful water jets
- Complies to outdoor applications
- Enclosure made of high quality PC materials and high temperature insulation
- Resistance to Ultra Violet (UV) radiation and anti-corrosion

### Isolator:

- High reliability with 4500 A rated short-circuit making capacity for isolators
- Complete accessories for easy installation

### Technical Specification

Standard Specifications	IEC 60947-3 (Third Edition) + A1:2012 + A2:2015
Number of poles	2P & 4P
Rated operational current	20 A, 32 A, 45 A, 63 A
Rated operational voltage	240 V/440 V
Rated insulation voltage	630 V
Rated impulse withstand voltage	2.5 KV 1.2/50 μs
Rated frequency	50/60 Hz
Rated utilization	AC-23 A
Rated making capacity	3 Ie
Rated breaking capacity	3 Ie
Rated short-time withstand current	15 Ie for 1 s
Rated short-circuit making capacity	4500 A
Pollution degree	3
Degree of protection	IP66

### Ordering details

Stock code	Type	Description
2TCZ751006R0001	WSD220CL	20 A 2P Switch-Isolator
2TCZ751006R0002	WSD232CL	32 A 2P Switch-Isolator
2TCZ751006R0003	WSD245CL	45 A 2P Switch-Isolator
2TCZ751006R0004	WSD263CL	63 A 2P Switch-Isolator
2TCZ751006R0005	WSD420CL	20 A 4P Switch-Isolator
2TCZ751006R0006	WSD432CL	32 A 4P Switch-Isolator
2TCZ751006R0007	WSD445CL	45 A 4P Switch-Isolator
2TCZ751006R0008	WSD463CL	63 A 4P Switch-Isolator

## Dimensions

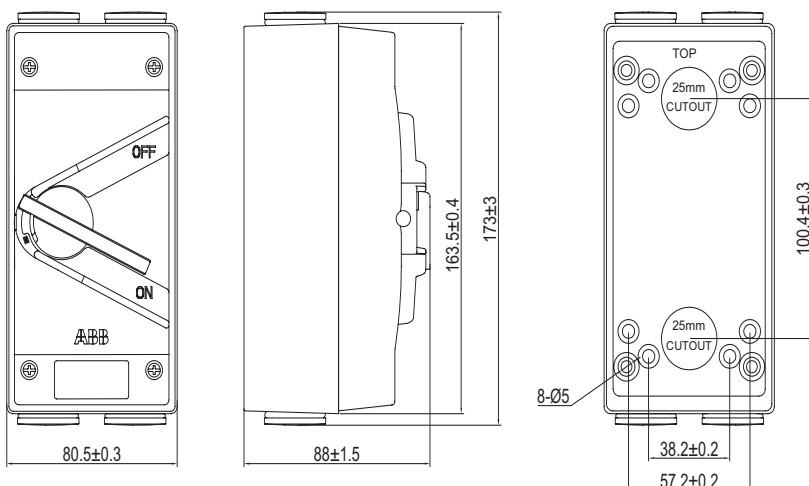

## Weatherproof Cover IP66



- Complies to outdoor applications
- Enclosure made of high quality PC material, glossy finish
- Resistance to UV radiation and anti-corrosion

### Technical Specification

Standard Specifications	IEC60670, IEC60529
Degree of protection	IP66
Self-holding	Yes
Padlock	Yes
Installation	Surface-mounted

### Ordering details

Stock code	Type	Description
2TCZ755003R0010	WSC102	1G WEATHERPROOF COVER IP66
2TCZ755004R0010	WSC202	2G WEATHERPROOF COVER IP66

## Dimensions

### WSC102

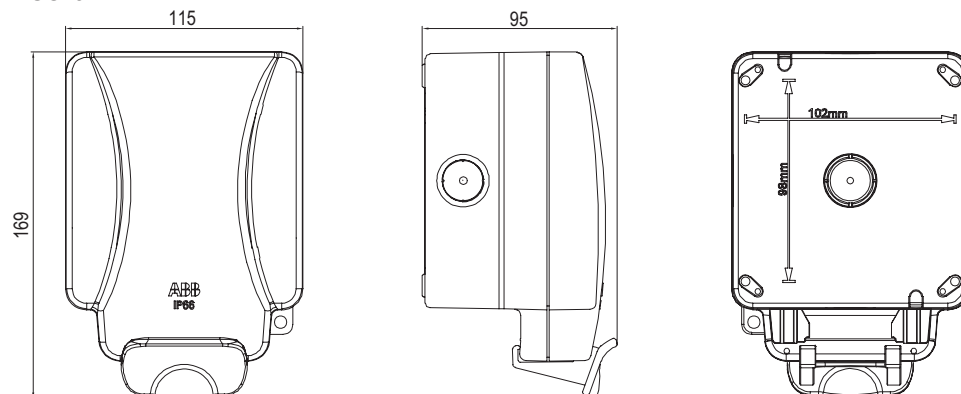

### WSC202

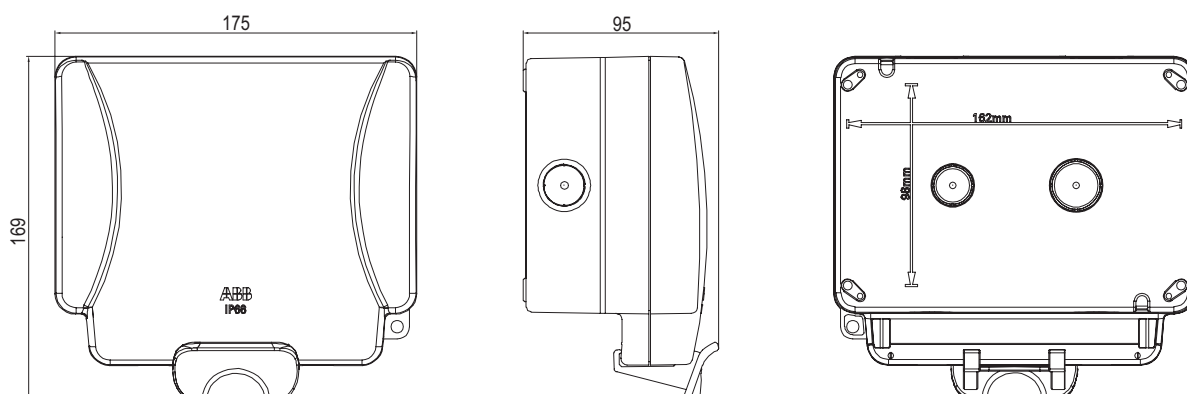

## Weatherproof Cover IP55

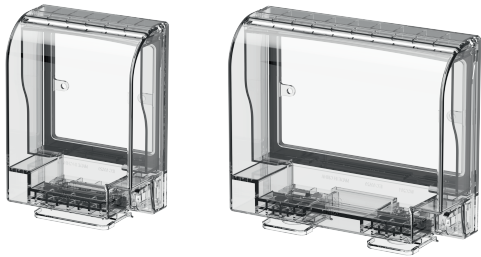

- UV stabilized Polycarbonate
- Transparent, impact resistant cover
- Soft pad to fill voids on uneven surface

### Technical Specification

Standard Specifications	IEC60670, IEC60529
Degree of protection	IP55
Self-holding	Yes
Padlock	Yes
Installation	Surface-mounted

### Ordering details

Stock code	Type	Description
2TCZ755001R0010	WSC101	1G WEATHERPROOF COVER IP55
2TCZ755002R0010	WSC201	2G WEATHERPROOF COVER IP55

## Dimensions

### WSC101

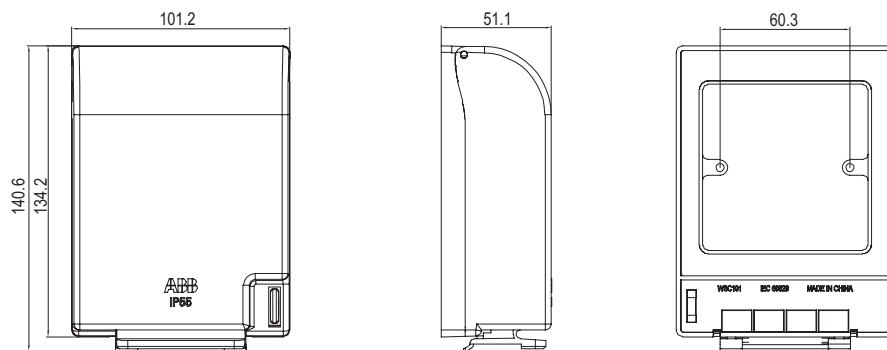

### WSC201

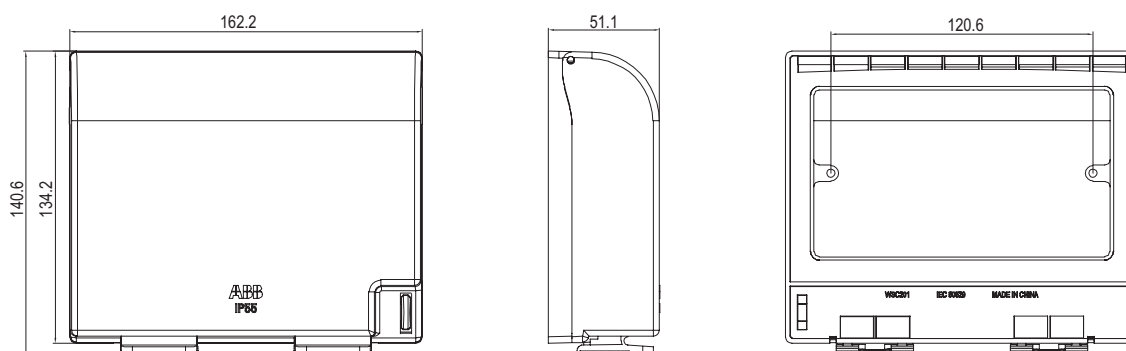



—

**ABB Saudi Arabia**

[contact.center@sa.abb.com](mailto:contact.center@sa.abb.com)

[new.abb.com/low-voltage/products/wiringaccessories](http://new.abb.com/low-voltage/products/wiringaccessories)